

Angle seat valves VZXF, NPT

FESTO



Angle seat valves VZXF, NPT

Key features



FESTO

Function

Angle seat valves are externally actuated valves. These valves are actuated by a direct supply of compressed air. In this process, the seat of the process valve is raised by means of a pneumatic actuator. In the normal position, the valve is closed by a spring. When the actuator is subjected to operating pressure, it raises the actuating piston and, at the same time, the valve disc too – the

valve opens. The valve seat is slanted at an angle of approx. 50° in relation to the medium flow. The direction of flow is determined by the design of the valve. Angle seat valves are used in applications in which absolute purity of the medium cannot be ensured, in which highly viscous media are to be controlled or in steam applications.

Design

-  Connecting thread
1/2 NPT ... 2 NPT
-  Flow rate Kv
3.3 ... 43 m³/h
- Gunmetal (red brass) variant
- Stainless steel casting variant
- Stainless steel casting variant, nickel-plated actuator head

General

- Angle seat valves are simple and sturdy and are thus perfectly suitable for almost all media with a viscosity of up to 600 mm²/s
- Angle seat valves control suitable gaseous and liquid media in rigid piping systems without the need for any pressure differential
- No pressure differential required between the inlet and outlet
- Low flow resistance
- Insensitive to steam or slightly contaminated media
- Long service life
- Low maintenance
- The valves have a high chemical and thermal resistance by virtue of their design
- The N/C function ensures that the valve is closed in the event of pressure loss in the control circuit
- Different designs of angle seat valves are available depending on the pressure of the medium
- There is a choice of two versions: “closing in the direction of medium flow” is used for gaseous media; “closing against the direction of media flow” is used for liquid media
- “Suitable for vacuum” is used for angle seat valves in packaging machines which need to generate a vacuum

Variants

VZXF-L-...-M-A-N112-350-H3B1-50-8

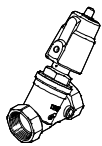

VZXF-L-...-M-A-N112-350-M1-V4V4T-50-7

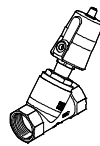

VZXF-L-...-M-A-N12-120-M1-H3B1-50-16

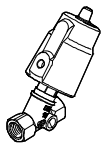

VZXF-L-...-M-B-N12-130-M1-V4V4T-50-40

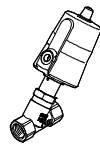

VZXF-L-...-M-B-N2-430-H3B1-50-3

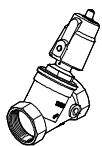

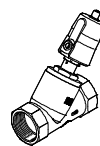

VZXF-L-...-M-B-N2-450-M1-V4V4T-50-3

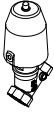

Angle seat valves VZXF, NPT

Product range overview

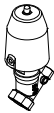
Version	Type	Process valve connection	Nominal size DN	Temperature of medium [°C]	Flow rate Kv [m³/h]	Process valve nominal pressure PN	→ Page/Internet
Gunmetal (red brass)							
	VZXF-L-...-H3B1-...	1/2 NPT	15	-10 ... +80	3.5 ... 28	16	6
		3/4 NPT	20				
		1 NPT	25				
		1 1/4 NPT	32				
		1 1/2 NPT	40				
		2 NPT	50				
Stainless steel casting							
	VZXF-L-...-V4V4T-...	1/2 NPT	15	-40 ... +200	3.3 ... 43	40	9
		3/4 NPT	20				
		1 NPT	25				
		1 1/4 NPT	32				
		1 1/2 NPT	40				
		2 NPT	50				
Stainless steel casting with nickel-plated actuator head							
	VZXF-L-...-V4B2T-...	1/2 NPT	15	-40 ... +200	3.3 ... 34.5	40	13
		3/4 NPT	20				
		1 NPT	25				
		1 1/4 NPT	32				
		1 1/2 NPT	40				
		2 NPT	50				

Angle seat valves VZXF, NPT

Type codes

VZXF - L - M22C - M - A - N12 - 120 -

Type

VZXF	Angle seat valve, externally actuated
------	---------------------------------------

Type of directional control valve

L	In-line valve
---	---------------

Valve function

M22C	2/2-way valve, normally closed
------	--------------------------------

Reset method for monostable valves

M	Mechanical spring
---	-------------------

Media flow

A	Above valve seat for gaseous media
B	Below valve seat for gaseous and liquid media

Process valve connection

N12	Thread 1/2 NPT
N34	Thread 3/4 NPT
N1	Thread 1 NPT
N114	Thread 1 1/4 NPT
N112	Thread 1 1/2 NPT
N2	Thread 2 NPT

Nominal width

120	12 mm
130	13 mm
160	16 mm
180	18 mm
230	23 mm
240	24 mm
290	29 mm
310	31 mm
350	35 mm
430	43 mm
450	45 mm

Temperature range of medium

-	Standard, -10 ... +80 °C
M1	-40 ... +200 °C

Angle seat valves VZXF, NPT

Type codes

		H3	B1		-	50	-	16
Housing material								
H3	Gunmetal (red brass)							
V4	Stainless steel							
Housing, actuator material								
AL	Aluminium							
AN	Nickel-plated aluminium							
B1	Brass							
B2	Nickel-plated brass							
V4	Stainless steel							
Sealing materials								
-	Standard, NBR							
T	PTFE							
V	FPM							
Actuator size								
50	50 mm							
80	80 mm							
Medium pressure								
V	-0.9 ... 0 bar							
3	Max. 3 bar							
4	Max. 4 bar							
5	Max. 5 bar							
6	Max. 6 bar							
7	Max. 7 bar							
8	Max. 8 bar							
9	Max. 9 bar							
10	Max. 10 bar							
12	Max. 12 bar							
16	Max. 16 bar							
20	Max. 20 bar							
22	Max. 22 bar							
25	Max. 25 bar							
40	Max. 40 bar							

Angle seat valves VZXF, NPT

Technical data – Gunmetal (red brass), temperature of medium –10 ... +80 °C

FESTO

Function

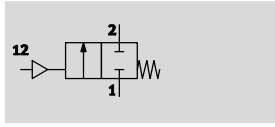

-  - Flow rate Kv
3.5 ... 28 m³/h

-  - Connecting thread
1/2 NPT ... 2 NPT



General technical data			
Process valve connection	1/2 NPT	3/4 NPT	1 NPT
Auxiliary pilot air port	G1/8		
Nominal size DN	15	20	25
Nominal width [mm]	12	16	23
Valve function	2/2-way, closed, monostable		
Design	Poppet valve with spring return		
Type of mounting	In-line installation		
Mounting position	Any		
Direction of flow	Non-reversible		
Exhaust function	No flow control		
Sealing principle	Soft		
Reset method	Mechanical spring		
Type of actuation	Pneumatic		
Type of pilot control	With external control		
Operating medium	Compressed air to ISO 8573-1:2010 [7:4:4]		

Process valve connection	1 1/4 NPT	1 1/2 NPT	2 NPT
Auxiliary pilot air port	G1/8		
Nominal size DN	32	40	50
Nominal width [mm]	29	35	43
Valve function	2/2-way, closed, monostable		
Design	Poppet valve with spring return		
Type of mounting	In-line installation		
Mounting position	Any		
Direction of flow	Non-reversible		
Exhaust function	No flow control		
Sealing principle	Soft		
Reset method	Mechanical spring		
Type of actuation	Pneumatic		
Type of pilot control	With external control		
Operating medium	Compressed air to ISO 8573-1:2010 [7:4:4]		

Angle seat valves VZXF, NPT

FESTO

Technical data – Gunmetal (red brass), temperature of medium –10 ... +80 °C

Operating and environmental conditions			
Process valve connection	1/2 NPT	3/4 NPT	1 NPT
Nominal pressure of process valve PN	16		
Medium	Filtered compressed air, grade of filtration 200 µm		
	Mineral oil-based hydraulic oil		
	Inert gases		
	Mineral oil		
	Neutral fluids		
	Water		
Max. viscosity	[mm ² /s]	600	
Ambient temperature	[°C]	–10 ... +60	
Temperature of medium	[°C]	–10 ... +80	
CE marking (see declaration of conformity)	–		

Process valve connection	1 1/4 NPT	1 1/2 NPT	2 NPT
Nominal pressure of process valve PN	16		
Medium	Filtered compressed air, grade of filtration 200 µm		
	Mineral oil-based hydraulic oil		
	Inert gases		
	Mineral oil		
	Neutral fluids		
	Water		
Max. viscosity	[mm ² /s]	600	
Ambient temperature	[°C]	–10 ... +60	
Temperature of medium	[°C]	–10 ... +80	
CE marking (see declaration of conformity) ¹⁾	To EU Pressure Equipment Directive		

1) Additional information www.festo.com/sp → Certificates.

Materials		Material number
Housing	Gunmetal (red brass)	CC499K
Actuator head	Brass	–
Stem seal	NBR	–
Seat seal	PTFE	–
Note on materials	Contains PWIS (paint-wetting impairment substances)	
	RoHS-compliant	

Angle seat valves VZXF, NPT

Technical data – Gunmetal (red brass), temperature of medium –10 ... +80 °C

Dimensions

Download CAD data → www.festo.com

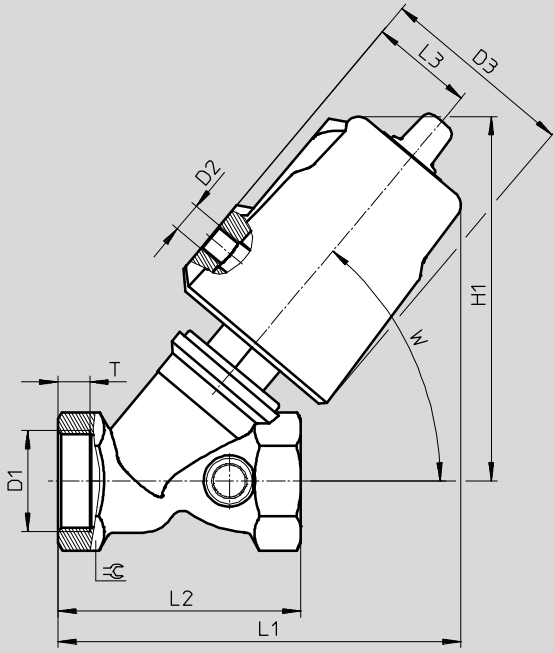

	D1	D2	D3 Ø	H1	L1	L2	L3	T	W	⊕
VZXF-L-...-N12-...-H3B1-50-...	1/2 NPT	G1/8	62	112	123	66	34	8	50°	27
VZXF-L-...-N34-...-H3B1-50-...	3/4 NPT			117	130	75		9		33
VZXF-L-...-N1-...-H3B1-50-...	1 NPT			121	133	80		10.5		41
VZXF-L-...-N114-...-H3B1-50-...	1 1/4 NPT			139	154	97		12.5		50
VZXF-L-...-N112-...-H3B1-50-...	1 1/2 NPT			145	161	107		14.5		56
VZXF-L-...-N2-...-H3B1-50-...	2 NPT			154	171	124		16.5		68

Ordering data – Angle seat valves VZXF

	Process valve connection	Flow rate Kv [m³/h]	Medium pressure [bar]	Corrosion resistance CRC ¹⁾	Product weight [g]	Part No.	Type
	1/2 NPT	3.5	0 ... 16	1	1200	1002533	VZXF-L-M22C-M-A-N12-120-H3B1-50-16
		3.7				1002534	VZXF-L-M22C-M-B-N12-120-H3B1-50-16
	3/4 NPT	6.7	0 ... 16		1300	1002535	VZXF-L-M22C-M-A-N34-160-H3B1-50-16
		5.2				1002536	VZXF-L-M22C-M-B-N34-160-H3B1-50-16
	1 NPT	10.8	0 ... 16		1500	1002537	VZXF-L-M22C-M-A-N1-230-H3B1-50-16
		9.6				1002538	VZXF-L-M22C-M-B-N1-230-H3B1-50-10
	1 1/4 NPT	19	0 ... 10		1900	1002539	VZXF-L-M22C-M-A-N114-290-H3B1-50-10
		6				1002540	VZXF-L-M22C-M-B-N114-290-H3B1-50-7
	1 1/2 NPT	23	0 ... 8		2300	1002541	VZXF-L-M22C-M-A-N112-350-H3B1-50-8
		16.5				1002542	VZXF-L-M22C-M-B-N112-350-H3B1-50-6
	2 NPT	28	0 ... 4		2800	1002543	VZXF-L-M22C-M-A-N2-430-H3B1-50-4
		23				1002544	VZXF-L-M22C-M-B-N2-430-H3B1-50-3

1) Corrosion resistance class CRC 1 to Festo standard FN 940070

Low corrosion stress. For dry indoor applications or transport and storage protection. Also applies to parts behind covers, in the non-visible interior area, and parts which are covered in the application (e.g. drive trunnions).

Angle seat valves VZXF, NPT

Technical data – Stainless steel casting, temperature of medium –40 ... 200 °C

Function

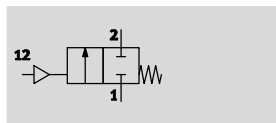

- - Flow rate Kv
3.3 ... 43 m³/h

- - Connecting thread
1/2 NPT ... 2 NPT



General technical data			
Process valve connection	1/2 NPT	3/4 NPT	1 NPT
Auxiliary pilot air port	G1/8		
Nominal size DN	15	20	25
Nominal width [mm]	13	18	24
Valve function	2/2-way, closed, monostable		
Design	Poppet valve with spring return		
Type of mounting	In-line installation		
Mounting position	Any		
Direction of flow	Non-reversible		
Exhaust function	No flow control		
Sealing principle	Soft		
Reset method	Mechanical spring		
Type of actuation	Pneumatic		
Type of pilot control	Externally actuated		
Pilot medium	Compressed air to ISO 8573-1:2010 [7:4:4]		

Process valve connection	1 1/4 NPT	1 1/2 NPT	2 NPT
Auxiliary pilot air port	G1/8		
Nominal size DN	32	40	50
Nominal width [mm]	31	35	45
Valve function	2/2-way, closed, monostable		
Design	Poppet valve with spring return		
Type of mounting	In-line installation		
Mounting position	Any		
Direction of flow	Non-reversible		
Exhaust function	No flow control		
Sealing principle	Soft		
Reset method	Mechanical spring		
Type of actuation	Pneumatic		
Type of pilot control	Externally actuated		
Pilot medium	Compressed air to ISO 8573-1:2010 [7:4:4]		

Angle seat valves VZXF, NPT

FESTO

Technical data – Stainless steel casting, temperature of medium –40 ... +200 °C

Operating and environmental conditions		1/2 NPT	3/4 NPT	1 NPT
Process valve connection		1/2 NPT	3/4 NPT	1 NPT
Nominal pressure of process valve PN		40		
Medium		Filtered compressed air, grade of filtration 200 µm		
		Mineral oil-based hydraulic oil		
		Inert gases		
		Mineral oil		
		Neutral fluids		
		Water		
		Steam		
Max. viscosity	[mm ² /s]	600		
Ambient temperature	[°C]	–10 ... 60		
Temperature of medium	[°C]	–40 ... 200		
CE marking (see declaration of conformity)		–		

Operating and environmental conditions		1 1/4 NPT	1 1/2 NPT	2 NPT
Process valve connection		1 1/4 NPT	1 1/2 NPT	2 NPT
Nominal pressure of process valve PN		40		
Medium		Filtered compressed air, grade of filtration 200 µm		
		Mineral oil-based hydraulic oil		
		Inert gases		
		Mineral oil		
		Neutral fluids		
		Water		
		Steam		
Max. viscosity	[mm ² /s]	600		
Ambient temperature	[°C]	–10 ... 60		
Temperature of medium	[°C]	–40 ... 200		
CE marking (see declaration of conformity) ¹⁾		To EU Pressure Equipment Directive		

1) Additional information www.festo.com/sp → Certificates.

Materials		Material number
Housing	Stainless steel casting	1.4408
Actuator head	Stainless steel	–
Stem seal	PTFE	–
Seat seal	PTFE	–
Note on materials	Contains PWIS (paint-wetting impairment substances)	
	RoHS-compliant	

Angle seat valves VZXF, NPT

Technical data – Stainless steel casting, temperature of medium –40 ... +200 °C

Dimensions

Download CAD data → www.festo.com

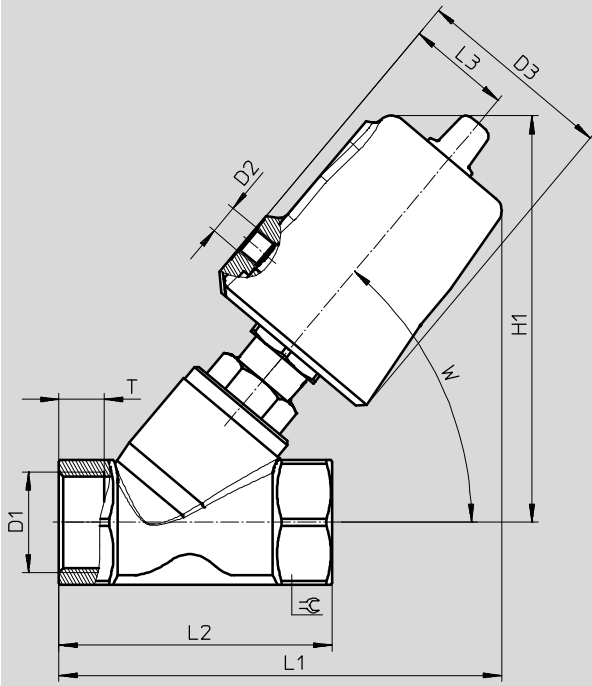

	D1	D2	D3 Ø	H1	L1	L2	L3	T	W	≈C
VZXF-L-...-N12-...-V4V4T-50-...	1/2 NPT	G1/8	62	129	135	65	34	12	50°	27
VZXF-L-...-N34-...-V4V4T-50-...	3/4 NPT			130	138	75		13		32
VZXF-L-...-N1-...-V4V4T-50-...	1 NPT			135	146	90	15	42		
VZXF-L-...-N1-...-V4V4T-80-...	1 NPT		94	177	184	48	42			
VZXF-L-...-N114-...-V4V4T-50-...	1 1/4 NPT		62	151	155	110	34	17		50
VZXF-L-...-N114-...-V4V4T-80-...	1 1/4 NPT		94	183	194	48	50			
VZXF-L-...-N112-...-V4V4T-50-...	1 1/2 NPT		62	155	174	120	34	19		55
VZXF-L-...-N112-...-V4V4T-80-...	1 1/2 NPT		94	187	202	48	55			
VZXF-L-...-N2-...-V4V4T-50-...	2 NPT		62	167	193	150	34	21		70
VZXF-L-...-N2-...-V4V4T-80-...	2 NPT		94	199	222	48	70			

Angle seat valves VZXF, NPT

Technical data – Stainless steel casting, temperature of medium –40 ... +200 °C

Ordering data – Angle seat valves VZXF							
	Process valve connection	Flow rate Kv [m³/h]	Medium pressure [bar]	Corrosion resistance CRC ¹⁾	Product weight [g]	Part No.	Type
	1/2 NPT	3.8	0 ... 25	3	1300	1002545	VZXF-L-M22C-M-A-N12-130-M1-V4V4T-50-25
		3.3	0 ... 40			1002546	VZXF-L-M22C-M-B-N12-130-M1-V4V4T-50-40
	3/4 NPT	7.5	0 ... 20	3	1400	1002547	VZXF-L-M22C-M-A-N34-180-M1-V4V4T-50-20
		6.5	0 ... 20			1002548	VZXF-L-M22C-M-B-N34-180-M1-V4V4T-50-20
	1 NPT	12	0 ... 16	3	1600	1002549	VZXF-L-M22C-M-A-N1-240-M1-V4V4T-50-16
		11	0 ... 10			1002550	VZXF-L-M22C-M-B-N1-240-M1-V4V4T-50-10
		12.5	0 ... 40		3600	1002551	VZXF-L-M22C-M-A-N1-240-M1-V4V4T-80-40
		12	0 ... 22			1002552	VZXF-L-M22C-M-B-N1-240-M1-V4V4T-80-22
	1 1/4 NPT	18.5	0 ... 9	3	2200	1002553	VZXF-L-M22C-M-A-N114-310-M1-V4V4T-50-9
		10.7	0 ... 7			1002554	VZXF-L-M22C-M-B-N114-310-M1-V4V4T-50-7
		19	0 ... 25		3800	1002555	VZXF-L-M22C-M-A-N114-310-M1-V4V4T-80-25
		17.5	0 ... 10			1002556	VZXF-L-M22C-M-B-N114-310-M1-V4V4T-80-10
	1 1/2 NPT	25	0 ... 7	3	2500	1002557	VZXF-L-M22C-M-A-N112-350-M1-V4V4T-50-7
		17.5	0 ... 6			1002558	VZXF-L-M22C-M-B-N112-350-M1-V4V4T-50-6
		29	0 ... 20		4300	1002559	VZXF-L-M22C-M-A-N112-350-M1-V4V4T-80-20
		28	0 ... 8			1002560	VZXF-L-M22C-M-B-N112-350-M1-V4V4T-80-8
	2 NPT	34.5	0 ... 4	3	3500	1002561	VZXF-L-M22C-M-A-N2-450-M1-V4V4T-50-4
		19.5	0 ... 3			1002562	VZXF-L-M22C-M-B-N2-450-M1-V4V4T-50-3
		43	0 ... 12		5400	1002563	VZXF-L-M22C-M-A-N2-450-M1-V4V4T-80-12
		39	0 ... 5			1002564	VZXF-L-M22C-M-B-N2-450-M1-V4V4T-80-5

1) Corrosion resistance class CRC 3 to Festo standard FN 940070
 High corrosion stress. Outdoor exposure under moderate corrosive conditions. External visible parts with primarily functional requirements for the surface and which are in direct contact with a normal industrial environment.

Angle seat valves VZXF, NPT

Technical data – Stainless steel casting with nickel-plated actuator head

Function

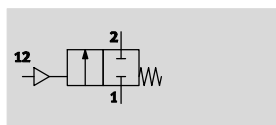

- - Flow rate Kv
3.3 ... 34.5 m³/h

- - 1/2 NPT ... 2 NPT



General technical data			
Process valve connection	1/2 NPT	3/4 NPT	1 NPT
Pneumatic connection	G1/8		
Nominal size DN	15	20	25
Nominal width [mm]	13	18	24
Valve function	2/2-way, closed, monostable		
Design	Poppet valve with spring return		
Type of mounting	In-line installation		
Mounting position	Any		
Direction of flow	Non-reversible		
Exhaust function	No flow control		
Sealing principle	Soft		
Reset method	Mechanical spring		
Type of actuation	Pneumatic		
Type of pilot control	Externally actuated		

Process valve connection	1 1/4 NPT	1 1/2 NPT	2 NPT
Pneumatic connection	G1/8		
Nominal size DN	32	40	50
Nominal width [mm]	31	35	45
Valve function	2/2-way, closed, monostable		
Design	Poppet valve with spring return		
Type of mounting	In-line installation		
Mounting position	Any		
Direction of flow	Non-reversible		
Exhaust function	No flow control		
Sealing principle	Soft		
Reset method	Mechanical spring		
Type of actuation	Pneumatic		
Type of pilot control	Externally actuated		

Angle seat valves VZXF, NPT

Technical data – Stainless steel casting with nickel-plated actuator head

Operating and environmental conditions						
Process valve connection	1/2 NPT		3/4 NPT		1 NPT	
Variant	...-M-A-...	...-M-B-...	...-M-A-...	...-M-B-...	...-M-A-...	...-M-B-...
Nominal pressure of process valve PN	40					
Operating pressure [bar]	6 ... 10					
Operating medium	Compressed air to ISO 8573-1:2010 [7:4:4]					
Medium	Vapour					
	Inert gases					
	Filtered compressed air, grade of filtration 200 µm					
	–	Mineral oil-based hydraulic oil	–	Mineral oil-based hydraulic oil	–	Mineral oil-based hydraulic oil
	–	Mineral oil	–	Mineral oil	–	Mineral oil
–	Neutral fluids	–	Neutral fluids	–	Neutral fluids	
–	Water	–	Water	–	Water	
Max. viscosity [mm ² /s]	600					
Ambient temperature [°C]	–10 ... +60					
Temperature of medium [°C]	–40 ... +200					
CE marking (see declaration of conformity)	–					

Process valve connection	1 1/4 NPT		1 1/2 NPT		2 NPT	
Variant	...-M-A-...	...-M-B-...	...-M-A-...	...-M-B-...	...-M-A-...	...-M-B-...
Nominal pressure of process valve PN	40					
Operating pressure [bar]	6 ... 10					
Operating medium	Compressed air to ISO 8573-1:2010 [7:4:4]					
Medium	Vapour					
	Inert gases					
	Filtered compressed air, grade of filtration 200 µm					
	–	Mineral oil-based hydraulic oil	–	Mineral oil-based hydraulic oil	–	Mineral oil-based hydraulic oil
	–	Mineral oil	–	Mineral oil	–	Mineral oil
–	Neutral fluids	–	Neutral fluids	–	Neutral fluids	
–	Water	–	Water	–	Water	
Max. viscosity [mm ² /s]	600					
Ambient temperature [°C]	–10 ... +60					
Temperature of medium [°C]	–40 ... +200					
CE marking (see declaration of conformity) ¹⁾	To EU Pressure Equipment Directive					

1) Additional information www.festo.com/sp → Certificates.

Materials		Material number
Housing	Stainless steel casting	1.4408
Actuator head	Nickel-plated brass	–
Stem seal	PTFE	–
Seat seal	PTFE	–
Note on materials	Contains PWIS (paint-wetting impairment substances)	
	RoHS-compliant	

Angle seat valves VZXF, NPT

Technical data – Stainless steel casting with nickel-plated actuator head

Dimensions

Download CAD data → www.festo.com

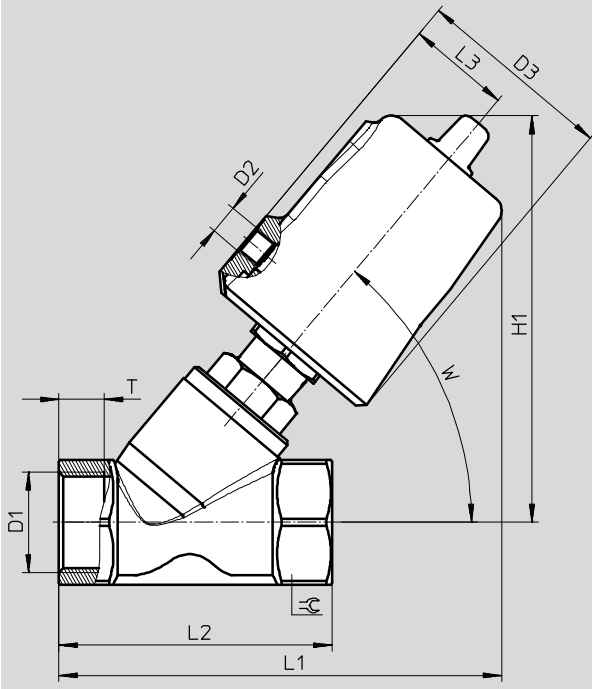

	D1	D2	D3 Ø	H1	L1	L2	L3	T	W	☉
VZXF-L-...-N12-...-V4B2T-50-...	1/2 NPT	G1/8	62	128	133	65	34	12	50°	27
VZXF-L-...-N34-...-V4B2T-50-...	3/4 NPT			128	136.5	75		13		32
VZXF-L-...-N1-...-V4B2T-50-...	1 NPT			133	145	90		15		41
VZXF-L-...-N114-...-V4B2T-50-...	1 1/4 NPT			150	163.5	110		17		50
VZXF-L-...-N112-...-V4B2T-50-...	1 1/2 NPT			153	172	120		19		55
VZXF-L-...-N2-...-V4B2T-50-...	2 NPT			167	193	150		21		70

Ordering data – Angle seat valves VZXF

	Process valve connection	Flow rate Kv [m³/h]	Medium pressure [bar]	Corrosion resistance CRC ¹⁾	Product weight [g]	Part No.	Type
	1/2 NPT	3.8	0 ... 40	2	1300	3539721	VZXF-L-M22C-M-A-N12-130-M1-V4B2T-50-40
		3.3				3539722	VZXF-L-M22C-M-B-N12-130-M1-V4B2T-50-40
	3/4 NPT	7.5	0 ... 20		1400	3539746	VZXF-L-M22C-M-A-N34-180-M1-V4B2T-50-20
		6.5				3539747	VZXF-L-M22C-M-B-N34-180-M1-V4B2T-50-20
	1 NPT	12	0 ... 16		1600	3539784	VZXF-L-M22C-M-A-N1-240-M1-V4B2T-50-16
		11				3539785	VZXF-L-M22C-M-B-N1-240-M1-V4B2T-50-10
	1 1/4 NPT	18.5	0 ... 9		2200	3539817	VZXF-L-M22C-M-A-N114-310-M1-V4B2T-50-9
		10.7	0 ... 7			3539818	VZXF-L-M22C-M-B-N114-310-M1-V4B2T-50-7
	1 1/2 NPT	25	0 ... 7		2500	3539928	VZXF-L-M22C-M-A-N112-350-M1-V4B2T-50-7
		17.5	0 ... 6			3539929	VZXF-L-M22C-M-B-N112-350-M1-V4B2T-50-6
	2 NPT	34.5	0 ... 4		3500	3540143	VZXF-L-M22C-M-A-N2-450-M1-V4B2T-50-4
		19.5	0 ... 3			3540144	VZXF-L-M22C-M-B-N2-450-M1-V4B2T-50-3

1) Corrosion resistance class CRC 2 to Festo standard FN 940070

Moderate corrosion stress. Indoor applications in which condensation may occur. External visible parts with primarily decorative requirements for the surface and which are in direct contact with the ambient atmosphere typical for industrial applications.