



- Multiple pressure ranges selectable
- Special adaptation to individual pressure ranges
- Setpoint value input as analogue voltage or current signal
- Optional setpoint module
- Connection sizes
G $\frac{1}{8}$, G $\frac{1}{4}$, G $\frac{1}{2}$



Proportional pressure regulators MPPE/VPPE/MPPES

Product range overview

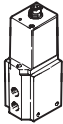

Proportional valves
Proportional pressure valves

6.1

Function	Version	Type	Constructional design	Pneumatic connection 1	Nominal size pressurising/exhaust [mm]	Pressure regulation range ¹⁾ [bar]	Setpoint value input		→ Page
							Voltage type 0 ... 10 V	Current type 4 ... 20 mA	
Pressure regulators	with pilot control via 2/2-way valves (switching valves)								
		MPPE	Pilot-actuated poppet valve	G $\frac{1}{8}$	5/5	0 ... 1 0 ... 2.5	■	■	2 / 6.1-8
				G $\frac{1}{4}$	7/7	0 ... 6	■	■	
				G $\frac{1}{2}$	11/12	0 ... 10	■	■	
		VPPE	Pilot-actuated poppet valve	G $\frac{1}{8}$	5/2.5	0.15 ... 6	■	-	2 / 6.1-4
	with proportional solenoid								
		MPPES	Directly-actuated valve	G $\frac{1}{8}$	3/2	0 ... 2 0 ... 6	■	■	2 / 6.1-14
			Pilot-actuated valve	G $\frac{1}{4}$	7/7	0 ... 10	■	■	
				G $\frac{1}{2}$	11/12		■	■	

1) Pressure regulation range also by customer request

Proportional pressure regulators MPPE/VPPE/MPPES

Peripherals overview

FESTO

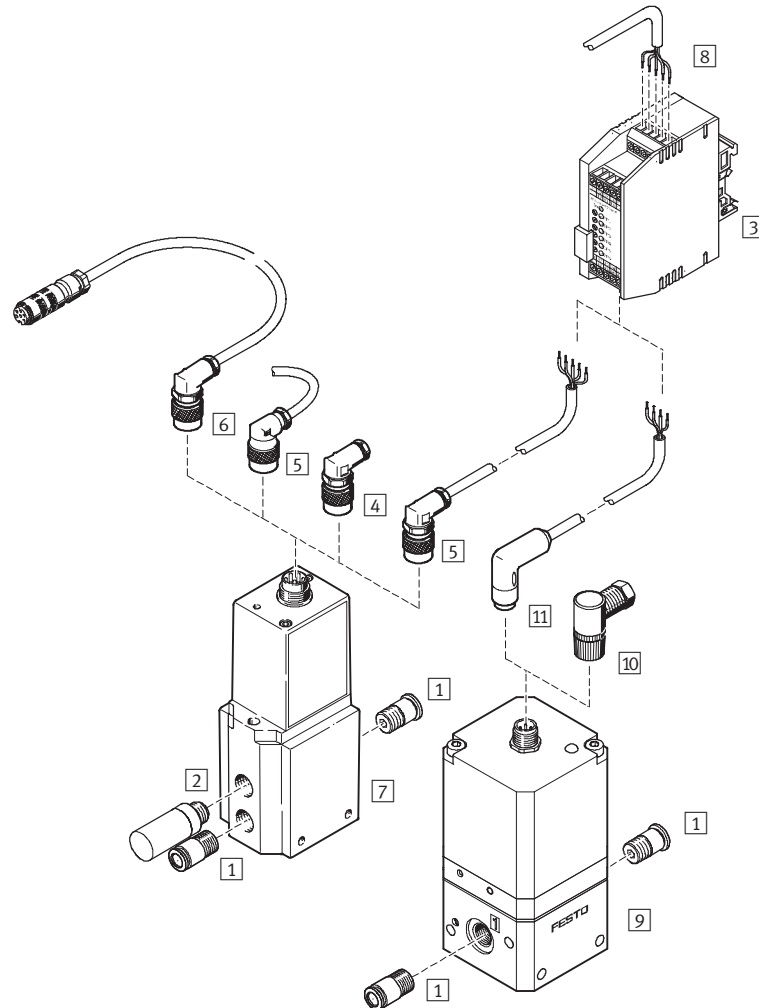

Accessories		
	Brief description	→ Page
1	Push-in fitting QS	Volume 3
2	Silencer	Volume 3
3	Setpoint value module MPZ	2 / 6.1-20
4	Angled plug socket MPPE-3-B	2 / 6.1-22
5	Plug socket with cable KMPE-B	2 / 6.1-22
6	Connecting cable KVIA-MPPE	2 / 6.1-22
7	Proportional pressure regulator MPPE	2 / 6.1-5
8	Digital input/output	–
9	Proportional pressure regulator VPPE	2 / 6.1-5
10	Plug socket, angled SIE-WD-TR	Volume 4
–	Plug socket, straight SIE-GD	Volume 4
11	Plug socket with cable, angled SIM-M12-4WD-5PU	2 / 6.1-22
–	Plug socket with cable, straight SIM-M12-4GD-5PU	2 / 6.1-22

Proportional pressure regulators VPPE

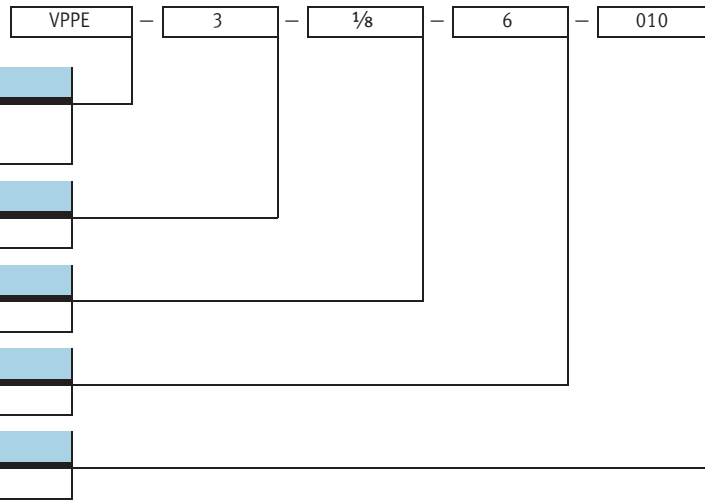

Type codes



Proportional pressure regulators VPPE

Technical data

FESTO

-  - Flow rate
600 l/min
-  - Voltage
21.6 ... 26.4 V DC
-  - Pressure regulation range
0.15 ... 6 bar

Variants
 ■ Setpoint value input as analogue voltage signal 0 ... 10 V



General technical data		
Pneumatic connection 1 and 2	G1/8	
Constructional design	Pilot-actuated piston regulator	
Sealing principle	Soft	
Actuation mode	Electrical	
Pilot control mode	Pilot actuated via 2/2-way valves	
Type of mounting	Via through-holes	
Assembly position	Any	
Nominal size	Ventilation [mm]	5
	Exhaust [mm]	2.5
Standard nominal flow rate	[l/min]	→ Graphs
Product weight	[g]	420

Flow rate q_n as a function of the output pressure p_2

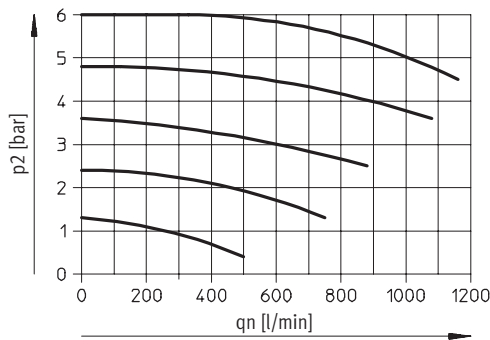

Electrical data	
Electrical connection	Plug, round design, 4-pin, M12x1
Operating voltage range [V DC]	21.6 ... 26.4
Residual ripple	10 %
Max. electrical power consumption [W]	2.5
Signal setpoint value input [V DC]	0 ... 10
Protection against short circuit	For all electrical connections
Protection against polarity reversal	For all electrical connections
Protection class	IP65
CE symbol	EU conformity in accordance with the directive 89/336/EEC (EMC)

Proportional pressure regulators VPPE

Technical data



Operating and environmental conditions	
Operating medium	Filtered compressed air, grade of filtration 40µm Neutral gases
Input pressure 1 [bar]	7 ... 8
Pressure regulation range [bar]	0.15 ... 6
Max. hysteresis [bar]	0.15
Ambient temperature [°C]	10 ... 50
Temperature of medium [°C]	10 ... 50
Corrosion resistance class CRC ¹⁾	2

1) Corrosion resistance class 2 according to Festo standard 940 070
Components requiring moderate corrosion resistance. Externally visible parts with primarily decorative surface requirements which are in direct contact with a normal industrial environment or media such as coolants or lubricating agents.

 - Safety advice

If the power supply cable is interrupted, output pressure is maintained unregulated.

Materials

Sectional view

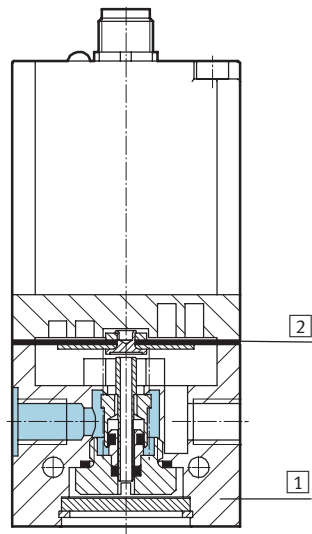

1	Housing	Wrought aluminium alloy
2	Diaphragm	Nitrile rubber

Proportional pressure regulators VPPE

Technical data

FESTO

Dimensions

Download CAD data → www.festo.com/en/engineering

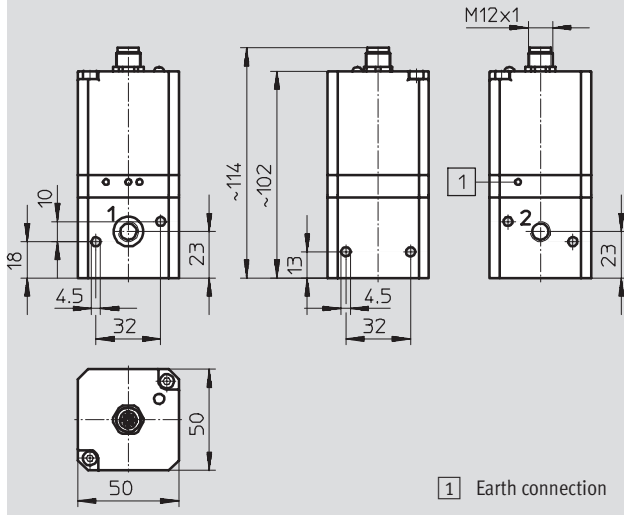

M12x1 – Terminal allocation



- 1 Power supply
21.6 ... 26.4 V DC
- 2 Nominal value (-)
- 3 GRD (-)
- 4 Nominal value (+) 0 ... 10 V DC

Ordering data

Pneumatic connection	Pressure regulation range [bar]	Part No.	Type
G $\frac{3}{8}$	0 ... 6	539 639	VPPE-3- $\frac{1}{8}$ -6-010

Proportional pressure regulators MPPE

Type codes



Basic version



MPPE		-	3	-	1/8	-	1	-	010	-	B
Type											
MPPE	Proportional pressure regulator with switching valve										
Valve function											
3	3-way pressure regulator										
Pneumatic connection											
1/8	G1/8										
1/4	G1/4										
1/2	G1/2										
Pressure regulation range											
1	0 ... 1 bar										
2.5	0 ... 2.5 bar										
6	0 ... 6 bar										
10	0 ... 10 bar										
Setpoint value input											
010	Analogue voltage signal										
420	Analogue current signal										
Generation											
B	B series										

Special pressure regulation range by customer request

MPPE		-	3	-	1/8	-	1	-	6	-	010	-	B
Type													
MPPE	Proportional pressure regulator with switching valve												
Valve function													
3	3-way pressure regulator												
Pneumatic connection													
1/8	G1/8												
1/4	G1/4												
1/2	G1/2												
Required pressure at 0 V or 4 mA [bar]													
Required pressure at 10 V or 20 mA [bar]													
Setpoint value input													
010	Analogue voltage signal												
420	Analogue current signal												
Generation													
B	B series												

Proportional pressure regulators MPPE

Technical data

-  - Flow rate
350 ... 5,500 l/min
-  - Voltage
18 ... 30 V DC
-  - Pressure regulation ranges
0 ... 1 bar
0 ... 2.5 bar
0 ... 6 bar
0 ... 10 bar

- Variants
- Setpoint value input as analogue voltage signal 0 ... 10 V
 - Setpoint value input as analogue current signal 4 ... 20 mA



General technical data					
Pneumatic connection		G1/8	G1/4	G1/2	
Constructional design		Pilot actuated piston regulator			
Sealing principle		Soft			
Actuation type		Electrical			
Type of pilot control		Pilot actuated using 2/2-way valves			
Type of mounting		Via through-holes			
Mounting position		Any			
Nominal size	Ventilation	[mm]	5	7	11
	Exhaust	[mm]	5	7	12
Standard nominal flow rate		[l/min]	→ Diagrams		
Product weight		[g]	710	920	2,400

Flow rate qn as a function of the output pressure p2

Pneumatic connection G1/8

Pressure regulation range 0 ... 1 bar

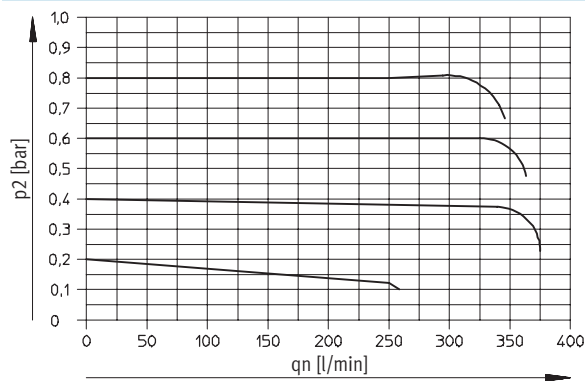

Pressure regulation range 0 ... 2.5 bar

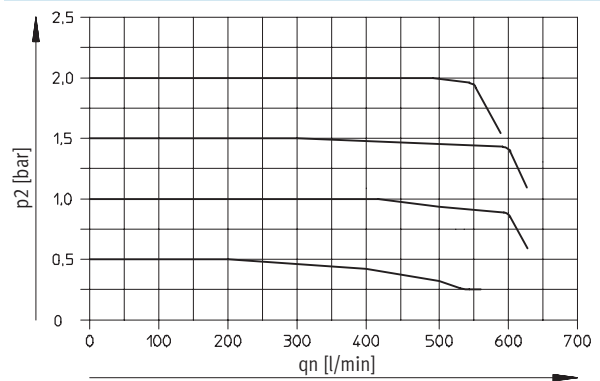

Pressure regulation range 0 ... 6 bar

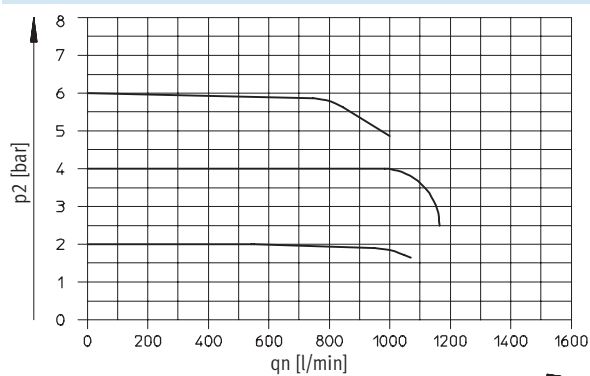

Pressure regulation range 0 ... 10 bar

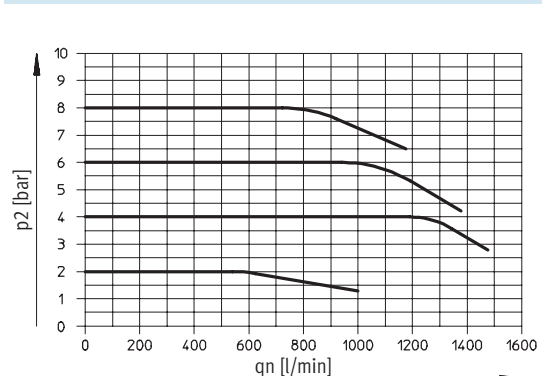

Proportional pressure regulators MPPE

Technical data



Flow rate q_n as a function of the output pressure p_2

Pneumatic connection $G\frac{1}{4}$

Pressure regulation range 0 ... 1 bar

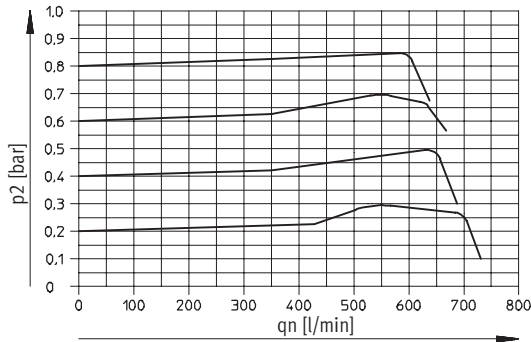

Pressure regulation range 0 ... 2.5 bar

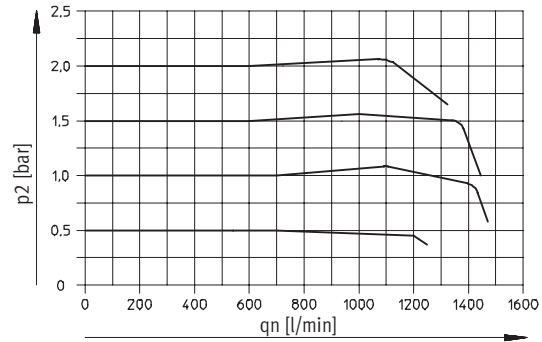

Pressure regulation range 0 ... 6 bar

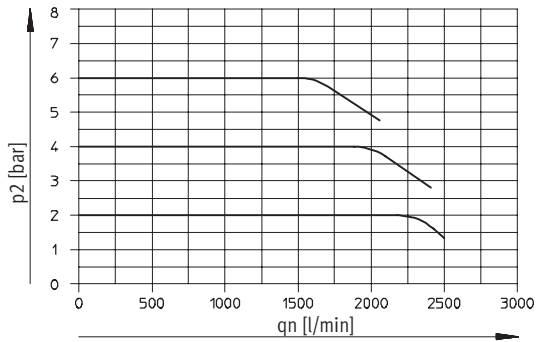

Pressure regulation range 0 ... 10 bar

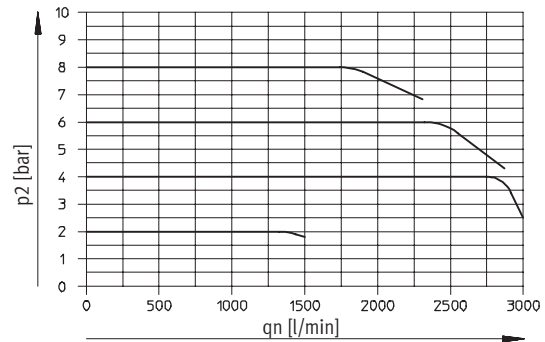

Pneumatic connection $G\frac{1}{2}$

Pressure regulation range 0 ... 1 bar

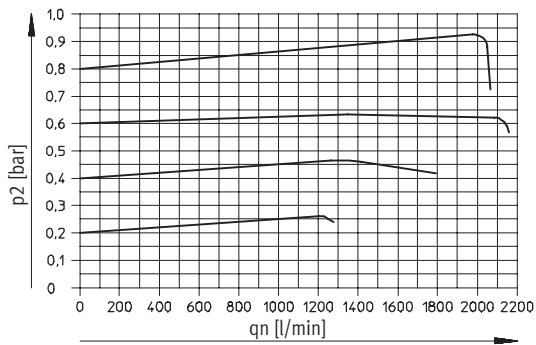

Pressure regulation range 0 ... 2.5 bar

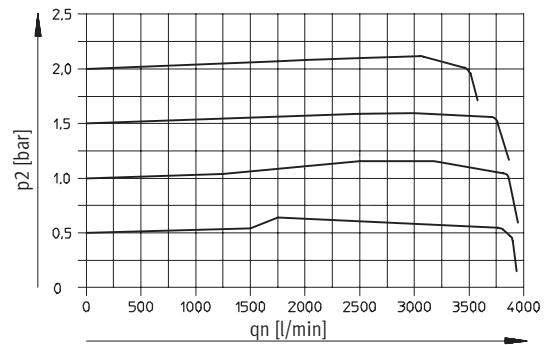

Pressure regulation range 0 ... 6 bar

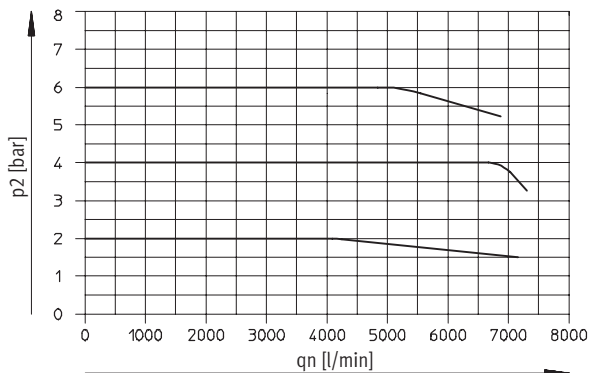

Pressure regulation range 0 ... 10 bar

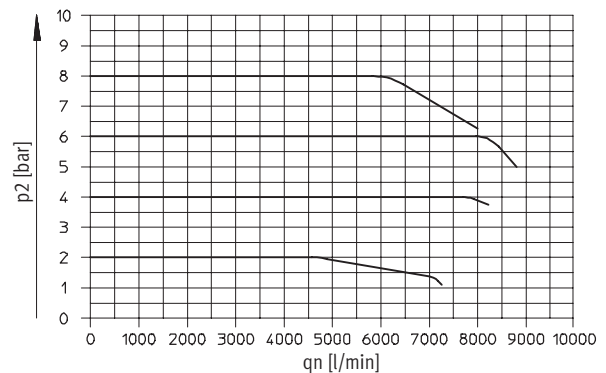

Proportional pressure regulators MPPE

Technical data

FESTO

Operating and environmental conditions					
Pressure regulation range	[bar]	0 ... 1	0 ... 2.5	0 ... 6	0 ... 10
Operating medium		Filtered compressed air, lubricated or unlubricated Neutral gases			
Input pressure 1	[bar]	1.5 ... 2	3.5 ... 4.5	7 ... 8	11 ... 12
Max. hysteresis	[mbar]	30	40	40	50
Ambient temperature	[°C]	0 ... 50			
Temperature of medium	[°C]	0 ... 60			
Corrosion resistance class CRC ¹⁾		2	2	2	2

1) Corrosion resistance class 2 according to Festo standard 940 070
Components requiring moderate corrosion resistance. Externally visible parts with primarily decorative surface requirements which are in direct contact with a surrounding industrial atmosphere or media such as cooling or lubricating agents.

Response times/step responses to output 2 at p _{1max} [s]									
Pressure regulation range [bar]	Volume to output 2	0 ... 1		0 ... 2.5		0 ... 6		0 ... 10	
		On ¹⁾	Off ²⁾	On ¹⁾	Off ²⁾	On ¹⁾	Off ²⁾	On ¹⁾	Off ²⁾
0 l	G ¹ / ₈	0.095	0.165	0.100	0.180	0.100	0.190	0.125	0.220
	G ¹ / ₄	0.140	0.225	0.150	0.260	0.150	0.260	0.160	0.280
	G ¹ / ₂	0.170	0.500	0.170	0.500	0.170	0.510	0.140	0.535
0.7 l	G ¹ / ₈	0.140	0.250	0.180	0.310	0.220	0.340	0.250	0.380
	G ¹ / ₄	0.150	0.280	0.170	0.320	0.180	0.360	0.200	0.390
	G ¹ / ₂	0.120	0.510	0.130	0.520	0.160	0.560	0.180	0.600
2 l	G ¹ / ₈	0.340	0.730	0.380	0.990	0.430	1.250	0.600	1.160
	G ¹ / ₄	0.360	0.620	0.400	0.700	0.540	0.930	0.540	1.050
	G ¹ / ₂	0.330	0.600	0.410	0.720	0.570	1.000	0.540	1.000

1) On = 0 ... 90% p_{2max}.
2) Off = 100 ... 10% p_{2max}.

Electrical data					
Pressure regulation range	[bar]	0 ... 1	0 ... 2.5	0 ... 6	0 ... 10
Electrical connection		Plug, round design to DIN 45 326, M16 x 0.75, 8-pin			
Operating voltage range	U _B [V DC]	18 ... 30	18 ... 30	18 ... 30	18 ... 30
Residual ripple		10%			
Power consumption	P _{max.} [W]	3.6 (at 30 V DC and 100% duty cycle)			
Signal setpoint value input	Voltage U _w [V DC]	0 ... 10	0 ... 10	0 ... 10	0 ... 10
	Current I _w [mA]	4 ... 20	4 ... 20	4 ... 20	4 ... 20
Signal actual value output	Voltage U _x [V DC]	0 ... 10	0 ... 10	0 ... 10	0 ... 10
	Current I _x [mA]	4 ... 20	4 ... 20	4 ... 20	4 ... 20
Signal actual value input external	Voltage U _{x,ext.} [V DC]	0 ... 10	0 ... 10	0 ... 10	0 ... 10
	Current I _{x,ext.} [mA]	4 ... 20	4 ... 20	4 ... 20	4 ... 20
Protection class to DIN 60 529		IP65 (with connection socket)			
Safety note		If the power supply cable is interrupted, output pressure is maintained unregulated			
Protection against polarity reversal	Setpoint value input Voltage signal 0 ... 10 V	For all electrical connections			
	Setpoint value input Current signal 4 ... 20 mA	For operating voltage			
Protection against short circuit		No			

Proportional pressure regulators MPPE

Technical data



Materials

Sectional view

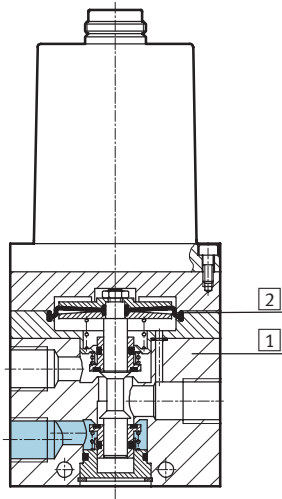

1	Housing	Wrought aluminium alloy
2	Diaphragm	Nitrile rubber

Dimensions

Download CAD data → www.festo.com/en/engineering

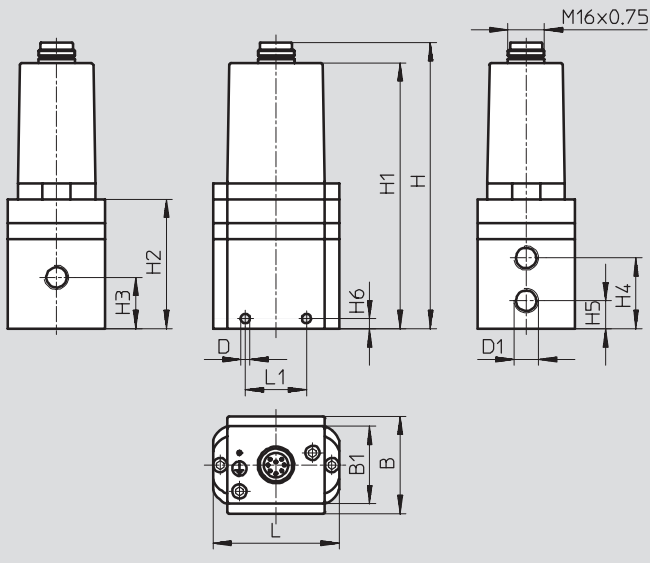

Pneumatic connection	B	B1	D	H	H1	H2	H3	H4	H5	H6	L	L1
D1			∅									
G $\frac{1}{8}$	38	–	4.5	129.1	119.1	60.2	18.8	26.8	9.3	4	62	34
G $\frac{1}{4}$	48	38	4.5	140.7	130.7	63.6	25.3	34.8	13.8	5	62	30
G $\frac{1}{2}$	76	38	7	194.6	184.6	117.5	53	74	32	18	86	50

Proportional pressure regulators MPPE

Technical data

FESTO

Terminal allocation

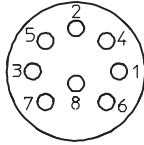

1	WH	X _{ext,in} (external actual value input)
2	BN	GND
3	GN	GND
4	YE	W _{in} (setpoint value input)
5	GY	10 V _{out} (external potentiometer supply)
6	PK	X _{out} (actual value output)
7	RD	24 V DC (supply voltage)
8	BU	GND

Switching function

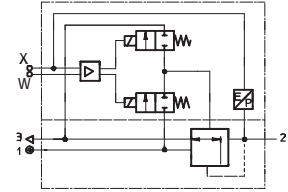

Ordering data

Pneumatic connection	Pressure regulation range [bar]	Voltage type 0 ... 10 V		Current type 4 ... 20 mA	
		Part No.	Type	Part No.	Type
Basic version					
G ¹ / ₈	0 ... 1	161 160	MPPE-3-1/8-1-010-B	161 163	MPPE-3-1/8-1-420-B
	0 ... 2.5	164 315	MPPE-3-1/8-2,5-010-B	164 316	MPPE-3-1/8-2,5-420-B
	0 ... 6	161 161	MPPE-3-1/8-6-010-B	161 164	MPPE-3-1/8-6-420-B
	0 ... 10	161 162	MPPE-3-1/8-10-010-B	161 165	MPPE-3-1/8-10-420-B
G ³ / ₄	0 ... 1	161 166	MPPE-3-1/4-1-010-B	161 169	MPPE-3-1/4-1-420-B
	0 ... 2.5	164 317	MPPE-3-1/4-2,5-010-B	164 318	MPPE-3-1/4-2,5-420-B
	0 ... 6	161 167	MPPE-3-1/4-6-010-B	161 170	MPPE-3-1/4-6-420-B
	0 ... 10	161 168	MPPE-3-1/4-10-010-B	161 171	MPPE-3-1/4-10-420-B
G ¹ / ₂	0 ... 1	161 172	MPPE-3-1/2-1-010-B	161 175	MPPE-3-1/2-1-420-B
	0 ... 2.5	164 319	MPPE-3-1/2-2,5-010-B	164 320	MPPE-3-1/2-2,5-420-B
	0 ... 6	161 173	MPPE-3-1/2-6-010-B	161 176	MPPE-3-1/2-6-420-B
	0 ... 10	161 174	MPPE-3-1/2-10-010-B	161 177	MPPE-3-1/2-10-420-B
Special adaptation type¹⁾					
G ¹ / ₈	0 ... 10	164 330	MPPE-3-1/8-...-...-010-B ¹⁾	164 330	MPPE-3-1/8-...-...-420-B ¹⁾
G ³ / ₄	0 ... 10	164 331	MPPE-3-1/4-...-...-010-B ¹⁾	164 331	MPPE-3-1/4-...-...-420-B ¹⁾
G ¹ / ₂	0 ... 10	164 332	MPPE-3-1/2-...-...-010-B ¹⁾	164 332	MPPE-3-1/2-...-...-420-B ¹⁾

1) The special adaptation type allows a lower pressure to be assigned to the setpoint value 0 V or 4 mA and an upper pressure to be assigned to the setpoint value 10 V or 20 mA. Upper and lower pressure by customer request.

Proportional pressure regulators MPPES

Type codes



Basic version

MPPES		–	3	–	1/8	–	1	–	010
Type									
MPPES	Proportional pressure regulator with proportional solenoid								
Valve function									
3	3-way pressure regulator								
Pneumatic connection									
1/8	G1/8								
1/4	G1/4								
1/2	G1/2								
Pressure regulation range									
2	0 ... 2 bar								
6	0 ... 6 bar								
10	0 ... 10 bar								
Setpoint value input									
010	Analogue voltage signal								
420	Analogue current signal								

Special pressure regulation range by customer request

MPPES		–	3	–	1/8	–	1	–	6	–	010
Type											
MPPES	Proportional pressure regulator with proportional solenoid										
Valve function											
3	3-way pressure regulator										
Pneumatic connection											
1/8	G1/8										
1/4	G1/4										
1/2	G1/2										
Required pressure at 0 V or 4 mA [bar]											
Required pressure at 10 V or 20 mA [bar]											
Setpoint value input											
010	Analogue voltage signal										
420	Analogue current signal										

Proportional pressure regulators MPPES



Technical data

- - Flow rate
230 ... 5,500 l/min
- - Voltage
18 ... 30 V DC
- - Pressure regulation ranges
0 ... 2 bar
0 ... 6 bar
0 ... 10 bar

- Variants
- Setpoint value input as analogue voltage signal 0 ... 10 V
 - Setpoint value input as analogue current signal 4 ... 20 mA



General technical data					
Pneumatic connection		G1/8	G1/4	G1/2	
Constructional design		Directly actuated piston regulator	Pilot actuated piston regulator		
Sealing principle		Soft			
Actuation type		Electrical			
Type of pilot control		Direct	Pilot actuated		
Type of mounting		Via through-holes			
Mounting position		Any			
Nominal size	Ventilation	[mm]	3	7	11
	Exhaust	[mm]	2	7	12
Standard nominal flow rate		[l/min]	→ Diagrams		
Product weight		[g]	915	1 310	2 670

Flow rate q_n as a function of the output pressure p_2

Pneumatic connection G1/8
 Pressure regulation range 0 ... 2 bar

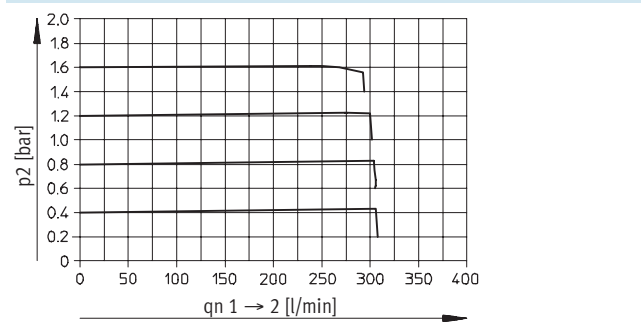

Pressure regulation range 0 ... 6 bar

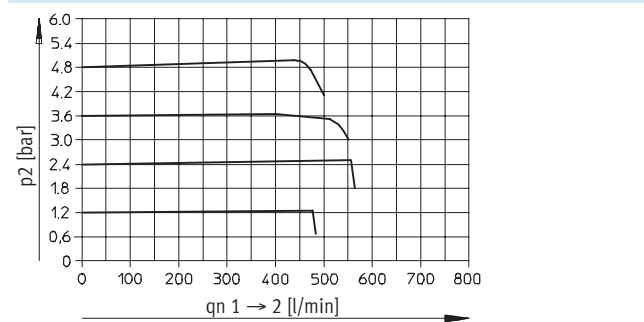

Pressure regulation range 0 ... 10 bar

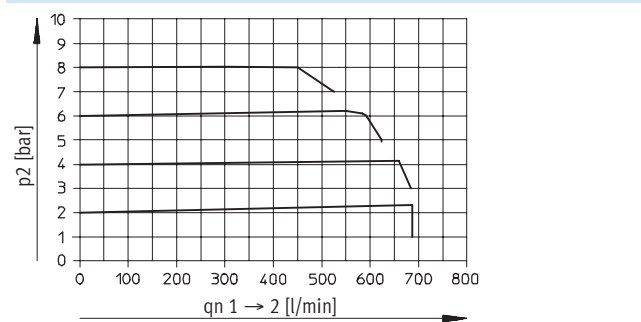

Proportional pressure regulators MPPES

Technical data



Flow rate q_n as a function of the output pressure p_2

Pneumatic connection $G\frac{1}{4}$

Pressure regulation range 0 ... 2 bar

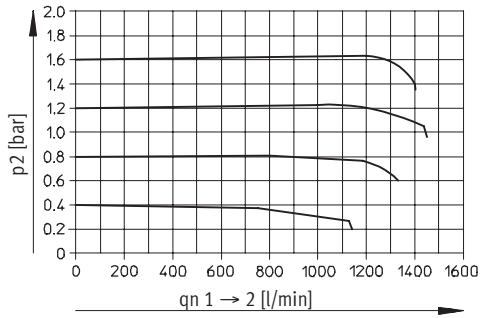

Pressure regulation range 0 ... 6 bar

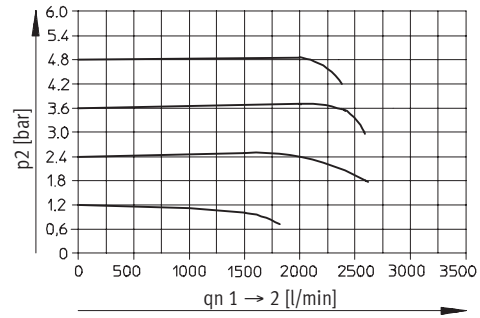

Pressure regulation range 0 ... 10 bar

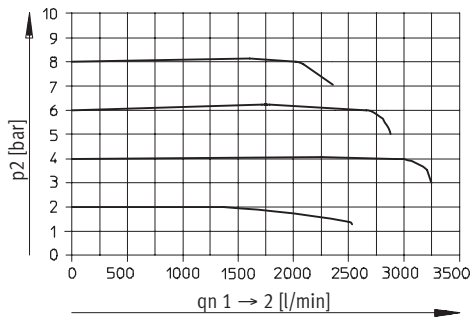

Pneumatic connection $G\frac{1}{2}$

Pressure regulation range 0 ... 2 bar

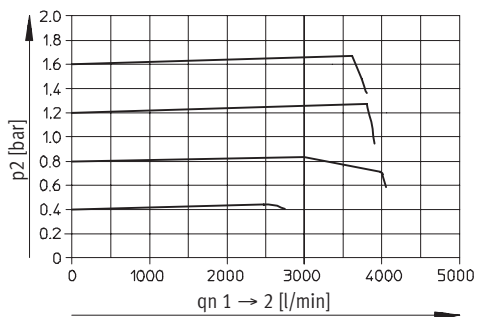

Pressure regulation range 0 ... 6 bar

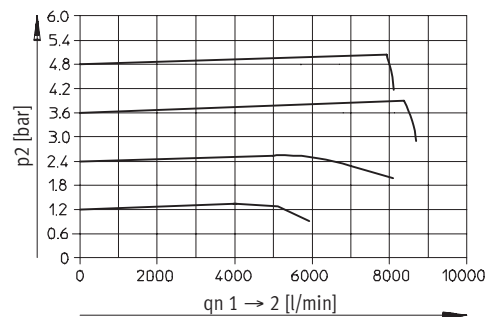

Pressure regulation range 0 ... 10 bar

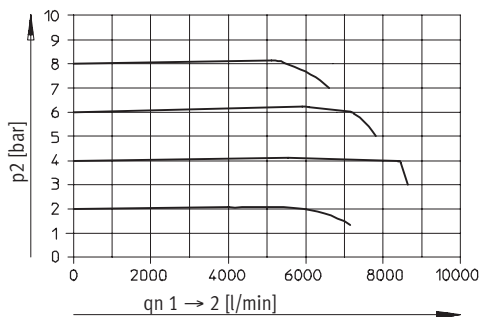

Proportional pressure regulators MPPES

Technical data

FESTO

Operating and environmental conditions				
Pressure regulation range	[bar]	0 ... 2	0 ... 6	0 ... 10
Operating medium		Filtered compressed air, lubricated or unlubricated Neutral gases		
Input pressure 1	[bar]	3 ... 4	7 ... 8	11 ... 12
Max. hysteresis	[mbar]	10	50	50
Ambient temperature	[°C]	0 ... 50		
Temperature of medium	[°C]	0 ... 60		
Corrosion resistance class CRC ¹⁾		2	2	2

- 1) Corrosion resistance class 2 according to Festo standard 940 070
Components requiring moderate corrosion resistance. Externally visible parts with primarily decorative surface requirements which are in direct contact with a surrounding industrial atmosphere or media such as cooling or lubricating agents.

Response times/step responses to output 2 at p _{1max} [s]							
Pressure regulation range [bar]	Volume to output 2	0 ... 2		0 ... 6		0 ... 10	
		On ¹⁾	Off ²⁾	On ¹⁾	Off ²⁾	On ¹⁾	Off ²⁾
0 l	G ¹ / ₈	0.220	0.410	0.210	0.280	0.200	0.290
	G ¹ / ₄	0.200	0.890	0.200	0.640	0.200	0.360
	G ¹ / ₂	0.220	1.000	0.230	0.660	0.230	0.450
2 l	G ¹ / ₈	0.660	2.530	1.200	5.760	1.370	6.300
	G ¹ / ₄	0.200	1.000	0.450	0.760	0.460	0.900
	G ¹ / ₂	0.320	1.000	0.340	0.570	0.350	0.630
10 l	G ¹ / ₈	2.700	2.800	5.150	24.000	5.800	27.000
	G ¹ / ₄	0.900	2.700	1.500	3.000	1.900	3.400
	G ¹ / ₂	0.800	1.400	1.100	1.500	1.300	1.800

- 1) On = 0 ... 90% p_{2max}.
2) Off = 100 ... 10% p_{2max}.

Electrical data				
Pressure regulation range	[bar]	0 ... 2	0 ... 6	0 ... 10
Electrical connection		Plug, round design to DIN 45 326, M16 x 0.75, 8-pin		
Operating voltage range	U _B [V DC]	18 ... 30	18 ... 30	18 ... 30
Residual ripple		10%		
Power consumption	P _{max.} [W]	20 (at 30 V DC)		
Signal setpoint value input	Voltage U _w [V DC]	0 ... 10	0 ... 10	0 ... 10
	Current I _w [mA]	4 ... 20	4 ... 20	4 ... 20
Signal actual value input	Voltage U _x [V DC]	0 ... 10	0 ... 10	0 ... 10
	Current I _x [mA]	4 ... 20	4 ... 20	4 ... 20
Signal actual value input external	Voltage U _{x,ext.} [V DC]	0 ... 10	0 ... 10	0 ... 10
	Current I _{x,ext.} [mA]	4 ... 20	4 ... 20	4 ... 20
Protection class to DIN 60 529		IP65 (with connection socket)		
Safety note		If the power supply cable is interrupted, output pressure is maintained unregulated.		
Protection against polarity reversal	Setpoint value input Voltage signal 0 ... 10 V	For all electrical connections		
	Setpoint value input Current signal 4 ... 20 mA	For operating voltage		
Protection against short circuit		No		

Proportional pressure regulators MPPES

Technical data



Materials

Sectional view

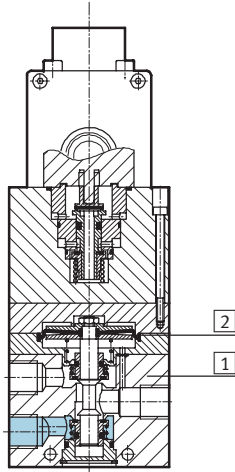

1	Housing	Wrought aluminium alloy
2	Diaphragm	Nitrile rubber

Dimensions

Download CAD data → www.festo.com/en/engineering

MPPES-3-1/8-...

MPPES-3-1/4-...
MPPES-3-1/2-...

MPPES-3-1/4-...
MPPES-3-1/2-...

MPPES-3-1/8-...

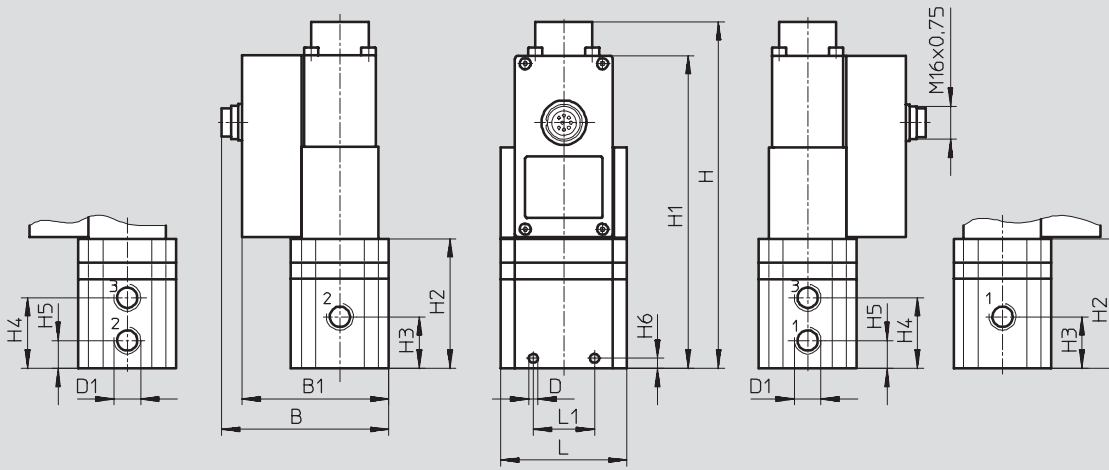

Pneumatic connection D1	B	B1	D Ø	H	H1	H2	H3	H4	H5	H6	L	L1
G1/8	77.1	67.1	4.4	116.5	100	55	34	45	23	4	62	34
G1/4	82.1	72.1	4.5	170.2	153.7	63.7	25.3	34.8	13.8	5	62	30
G1/2	96.1	86.1	7	227.1	210.6	120.6	53	74	32	18	86	50

Proportional pressure regulators MPPES

Technical data

FESTO

Proportional valves
Proportional pressure valves

6.1

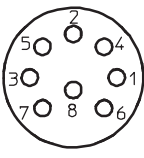
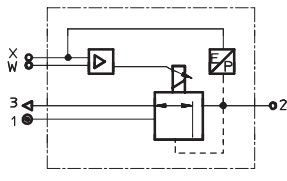
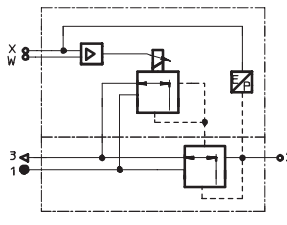
Connections			Switching function	
Terminal allocation			MPPES-3-1/8-...	MPPES-3-1/4-.../MPPES-3-1/2-...
	1 WH	n. c.		
	2 BN	GND		
	3 GN	GND		
	4 YE	W_{in} (setpoint value input)		
	5 GY	n. c.		
	6 PK	X_{out} (actual value output)		
	7 RD	24 V DC (supply voltage)		
	8 BU	GND		

Ordering data					
Pneumatic connection	Pressure regulation range [bar]	Voltage type 0 ... 10 V		Current type 4 ... 20 mA	
		Part No.	Type	Part No.	Type
Basic version					
G ¹ / ₈	0 ... 2	187 350	MPPES-3-1/8-2-010	187 351	MPPES-3-1/8-2-420
	0 ... 6	187 352	MPPES-3-1/8-6-010	187 353	MPPES-3-1/8-6-420
	0 ... 10	187 348	MPPES-3-1/8-10-010	187 349	MPPES-3-1/8-10-420
G ¹ / ₄	0 ... 2	187 335	MPPES-3-1/4-2-010	187 336	MPPES-3-1/4-2-420
	0 ... 6	187 337	MPPES-3-1/4-6-010	187 338	MPPES-3-1/4-6-420
	0 ... 10	187 333	MPPES-3-1/4-10-010	187 334	MPPES-3-1/4-10-420
G ¹ / ₂	0 ... 2	187 328	MPPES-3-1/2-2-010	187 329	MPPES-3-1/2-2-420
	0 ... 6	187 330	MPPES-3-1/2-6-010	187 331	MPPES-3-1/2-6-420
	0 ... 10	187 326	MPPES-3-1/2-10-010	187 327	MPPES-3-1/2-10-420
Special adaptation type¹⁾					
G ¹ / ₈	0 ... 10	187 347	MPPES-3-1/8-PU-PO-010	187 762	MPPES-3-1/8-PU-PO-420
G ¹ / ₄	0 ... 10	187 339	MPPES-3-1/4-PU-PO-010	187 744	MPPES-3-1/4-PU-PO-420
G ¹ / ₂	0 ... 10	187 332	MPPES-3-1/2-PU-PO-010	187 735	MPPES-3-1/2-PU-PO-420

1) The special adaptation type allows a lower pressure PU to be assigned to the setpoint value 0 V or 4 mA and an upper pressure PO to be assigned to the setpoint value 10 V or 20 mA. PU and PO by customer request.

Proportional pressure regulators MPPE/VPPE/MPPES

Accessories



Setpoint module MPZ

 Voltage
20 ... 30 V DC

Function

- Generation of 6+1 analogue setpoint values for the proportional pressure regulators MPPE, MPPES and MPYE
- Digital controller
- Output voltage adjustable via spindle potentiometer



General technical data			
Mode of operation		Digital-analogue circuit with analogue output	
Electrical connection		Screw terminal	
Connection cross section	[mm ²]	2.5	
Operating voltage range	[V DC]	20 ... 30	
Adjustable output voltage	[V DC]	0 ... 10	
Max. output current	[mA]	27	
Power consumption at 24 V DC	[W]	1.5	
Supply setpoint value adjustment	Voltage	[V]	10 ... 10.6
	Current	[mA]	6 ... 6.36
External setpoint input	Voltage	[V DC]	0 ... 10
	Potentiometer	[kΩ]	2.5 ... 10
Setpoint controller	Input resistance	[kΩ]	3
Residual ripple	[%]		Max. 10
Display	Ready		Green LED
	Setpoint active		Yellow LED
Type of mounting			On H-rail
Assembly position			Any
Product weight	[g]		80

Operating and environmental conditions			
Ambient temperature	[°C]		0 ... 60
Protection class			IP20
CE symbol (declaration of conformity)			In accordance with EU EMC directive
Corrosion resistance class CRC ¹⁾			2

1) Corrosion resistance class 2 according to Festo standard 940 070
Components requiring moderate corrosion resistance. Externally visible parts with primarily decorative surface requirements which are in direct contact with a normal industrial environment or media such as coolants or lubricating agents

Proportional pressure regulators MPPE/VPPE/MPPES

Accessories



Connections and control elements

Connections			Priority
31	Activate setpoint 1	SP1	1 (highest)
32	Activate setpoint 2	SP2	2
33	Activate setpoint 3	SP3	3
34	Activate setpoint 4	SP4	4
35	Activate setpoint 5	SP5	5
11	Activate setpoint 6	SP6	6
13	Control line	0 V	-
21	Control line	0 V	-
22	External setpoint input	$U_{w, in} = 0 \dots 10 \text{ V DC}$	7 (lowest)
23	Control line	10 V DC	-
24	Screening	PE	-
41	Control line	0 V DC	-
42	Setpoint output	$U_{w, out}$	-
43	Power supply	-	-
45	Power supply	+	-

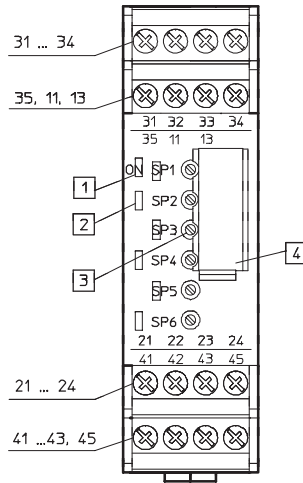

- 1 Operational status display, green LED
- 2 Setpoint display active (SP1 ... SP6), yellow LED
- 3 Setpoint potentiometer SP1 ... SP6
- 4 Inscription label

Dimensions

Download CAD data → www.festo.com/en/engineering

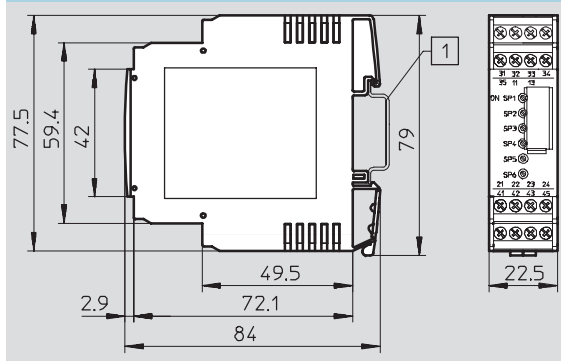

- 1 H-rail to DIN EN 60715

Proportional valves
Proportional pressure valves

6.1









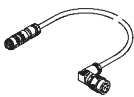

Proportional pressure regulators MPPE/VPPE/MPPES

Accessories



Proportional valves
Proportional pressure valves

6.1

Ordering data				
	Description	Cable length [m]	Part No.	Type
Connecting cable Technical data → 2 / 7.3-23				
	Connecting cable to the analogue module of valve terminal type 03/04	5	163 882	KVIA-MPPE-5
		10	163 883	KVIA-MPPE-10
Plug socket with cable Technical data → 2 / 7.2-20				
	Straight, 4-pin, M12x1	5	164 259	SIM-M12-4GD-5-PU
Plug socket with cable Technical data → 2 / 7.2-20				
	Angled, 4-pin, M12x1	5	164 258	SIM-M12-4WD-5-PU
Plug socket with cable Technical data → 2 / 7.3-38				
	Angled, 8-pin, M16x0.75	2.5	161 879	KMPPE-...-B-2,5
		5	161 878	KMPPE-...-B-5
Sensor socket Technical data → 2 / 7.2-21				
	Straight, 4-pin, M12x1	-	18 494	SIE-GD
Sensor socket Technical data → 2 / 7.2-21				
	Angled, 4-pin, M12x1	-	12 956	SIE-WD-TR
Angled plug socket Technical data → 2 / 7.2-10				
	Angled, 8-pin, M16x0.75	-	161 839	MPPE-3-B
Push-in fitting Technical data → Volume 3				
	For connecting compressed air tubing with standard external diameters			
Silencer Technical data → Volume 3				
	For fitting in exhaust ports			
Reducing nipple Technical data → Volume 3				
	-			

1) Max. 10 m



- High dynamics
- Final control element for closed control loops
- 5/3 –way function

Proportional directional control valves MPYE

Product range overview

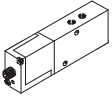
Function	Design	Type	Construc- tional design	Pneumatic connection	Nominal size [mm]	Standard nominal flow rate [l/min]	Setpoint/actual values		→ Page	
							Voltage type	Current type		
5/3-way valves		MPYE	Piston spool	M5	2	0 ... 100	0 ... 10 V	4 ... 20 mA	Volume 5	
					G ¹ / ₈	4 ¹⁾	0 ... 350 ¹⁾			
						6 ²⁾	0 ... 700 ²⁾			
					G ¹ / ₄	8	0 ... 1400			
					G ³ / ₈	10	0 ... 2000			

- 1) Low flow version
- 2) High flow version