

## Axis controllers CPX-CMAX

**FESTO**



## Overview

### Servo-pneumatic drive technology

Positioning and Soft Stop applications as an integral component of the valve terminal CPX – the modular peripheral system for decentralised automation tasks. The modular design means that valves, digital inputs and outputs, positioning modules and end-position controllers, as appropriate to the application, can be combined in almost any way on the CPX terminal.

#### Advantages:

- Pneumatics and electrics – control and positioning on one platform
- Innovative positioning technology – piston rod drives, rodless drives, rotary drives
- Actuation via fieldbus
- Remote maintenance, remote diagnostics, web server, SMS and e-mail alerts are all possible via TCP/IP
- Modules can be quickly exchanged and expanded without altering the wiring

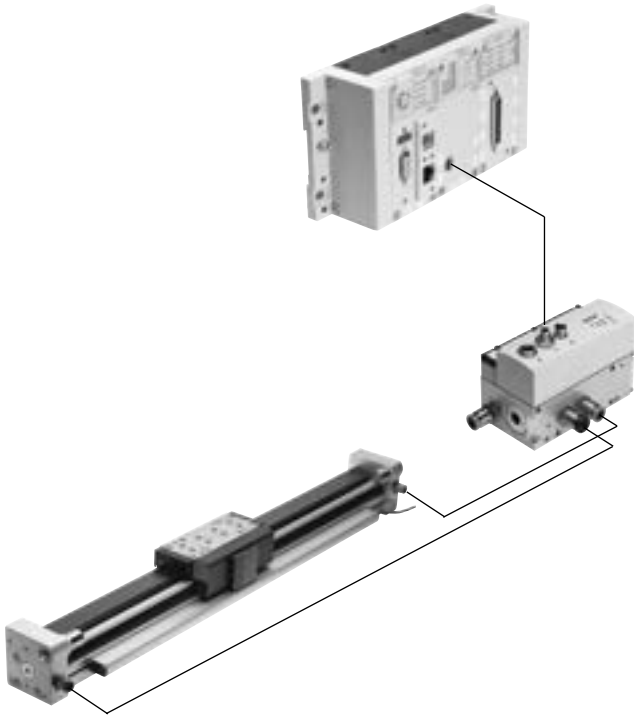

## Key features

## Axis controller CPX-CMAX



**Free choice:**  
Position and force control, directly actuated or selected from one of 128 configurable position sets.  
If you are looking for something more: The configurable record sequencing function enables simple functional sequences to be realised in the axis controller CPX-CMAX.  
**Everything is recognisable:**  
The auto-identification function identifies each participant with its device data on the controller CPX-CMAX.

**Also included:**  
Actuation of a brake or clamping unit via the proportional directional control valve VPWP is also part of the scope of performance of the controller CPX-CMAX.  
Up to 8 modules (max. 8 axes) can be operated in parallel and independently of each other.  
Commissioning via FCT (Festo configuration software) or via fieldbus:  
No programming, only configuration.

**Advantages:**

- Greater flexibility
- OEM friendly – commissioning also via fieldbus
- Easy installation and fast commissioning
- Cost-effective
- You program the system in your PLC environment

## End-position controller CPX-CMPX

Data sheets → Internet: [cpx-cmpx](http://cpx-cmpx)

Fast travel between the mechanical end stops of the cylinder, stopping gently and without impact in the end position.  
Fast commissioning via control panel, fieldbus or handheld unit.  
Improved control of standstills.  
Actuation of a brake or clamping unit via the proportional directional control valve VPWP is an integral part of the controller CMPX.

Depending on the fieldbus chosen, up to 9 end-position controllers can be actuated on the CPX terminal.  
All system data can be read and written via the fieldbus, including, for example, the mid-positions.

**Advantages:**

- Greater flexibility
- OEM friendly – commissioning also via fieldbus
- Easy installation and fast commissioning
- Cost-effective
  - Up to 30% faster cycle rates
  - Significantly reduced system vibration
- Improved work ergonomics thanks to significantly reduced noise level
- The extended diagnostics help to reduce the service time of the machine

## Proportional directional control valve VPWP

Data sheets → Internet: [vpwp](http://vpwp)

The 5/3-way proportional directional control valve for applications with Soft Stop and pneumatic positioning.  
Fully digitalised – with integrated pressure sensors, with new diagnostic functions.  
In sizes 4, 6, 8 and 10.  
Flow rates of 350, 700, 1400 and 2000 l/min.

With switching output for controlling a brake.  
Coloured compressed air supply ports.  
Pre-assembled cables guarantee faultless and fast connection with the controllers CPX-CMPX and CPX-CMAX.

**Advantages:**

- Easy installation and fast commissioning
- Reduction of system downtimes thanks to the new diagnostic options
- With switching output for actuating a brake/clamping unit

## Drive options

### System with linear drive DDLI, DGCI

Data sheets → Internet: ddli or dgc

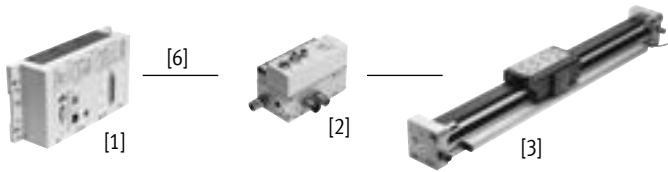

- [1] Controller module CPX-CMPX or CPX-CMAX
- [2] Proportional directional control valve VPWP
- [3] Linear drive DDLI, DGCI with displacement encoder
- [6] Connecting cable KVI-CP-3...

- Pneumatic rodless linear drive with displacement encoder, with or without recirculating ball bearing guide
- Displacement encoder with absolute and contactless measurement
- Diameter:
  - With DGCI: 18 ... 63 mm
  - With DDLI: 25 ... 63 mm
- Stroke: 100 ... 2000 mm in fixed lengths
- Range of applications: Soft Stop and pneumatic positioning
- Loads from 1 ... 180 kg
- No sensor interface required

#### Advantages:

- Complete drive unit
- DDLI for easy connection to the customer's guide system
- Excellent running characteristics
- For fast and accurate positioning down to  $\pm 0.2$  mm (only with axis controller CPX-CMAX)

### System with standards-based cylinder DNCI, DDPC

Data sheets → Internet: dnci

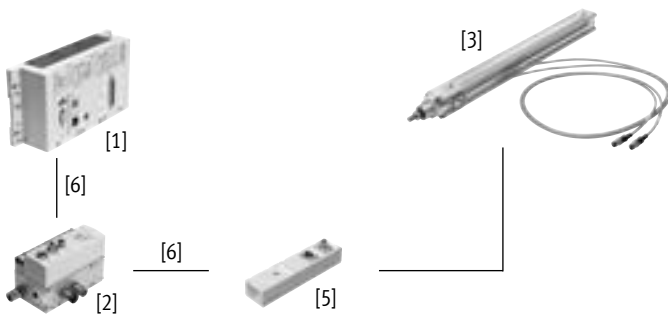

- [1] Controller module CPX-CMPX or CPX-CMAX
- [2] Proportional directional control valve VPWP
- [3] Standards-based cylinder DNCI, DDPC with displacement encoder
- [5] Sensor interface: CASM-S-D3-R7
- [6] Connecting cable KVI-CP-3...

- Standards-based cylinder with integrated displacement encoder, conforms to DIN ISO 6432, VDMA 24 562, NF E 49 003.1 and Uni 10 290
- Displacement encoder with contactless and incremental measuring
- Diameter 32 ... 100 mm
- Stroke: 100 ... 750 mm
- Range of applications: Soft Stop and pneumatic positioning
- Loads from 3 ... 450 kg and the corresponding sensor interface CASM-S-D3-R7
- Pre-assembled cables guarantee faultless and fast electrical connection

#### Advantages:

- Compact drive unit
- Can be used universally
- Also with guide unit
- For fast and accurate positioning down to  $\pm 0.5$  mm (only with axis controller CPX-CMAX)

## Drive options

## System with semi-rotary drive DSMI

Data sheets → Internet: dsmi

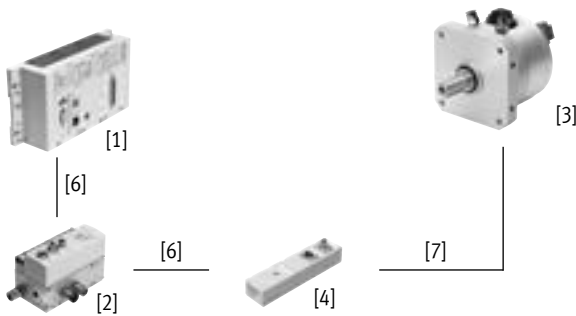

- [1] Controller module CPX-CMPX or CPX-CMAX
- [2] Proportional directional control valve VPWP
- [3] Semi-rotary drive DSMI with displacement encoder
- [4] Sensor interface CASM-S-D2-R3
- [6] Connecting cable KVI-CP-3-...
- [7] Connecting cable NEBC-P1W4-K-0.3-N-M12G5

- Semi-rotary drive DSMI with integrated displacement encoder
- Identical design to pneumatic semi-rotary drive DSM
- Absolute displacement encoder based on a potentiometer
- Swivel range from 0 ... 270°
- Size: 25, 40, 63
- Max. torque: 5 ... 40 Nm
- Range of applications: Soft Stop and pneumatic positioning
- Mass moments of inertia of 15 ... 6000 kgcm<sup>2</sup> and the corresponding sensor interface CASM-S-D2-R3
- Pre-assembled cables guarantee faultless and fast connection with the proportional directional control valve VPWP

## Advantages:

- Complete drive unit, compact, can be used immediately
- High angular acceleration
- With adjustable fixed stops
- For fast and accurate positioning down to ±0.2° (only with axis controller CPX-CMAX)

## System with potentiometer

Data sheets → Internet: casm

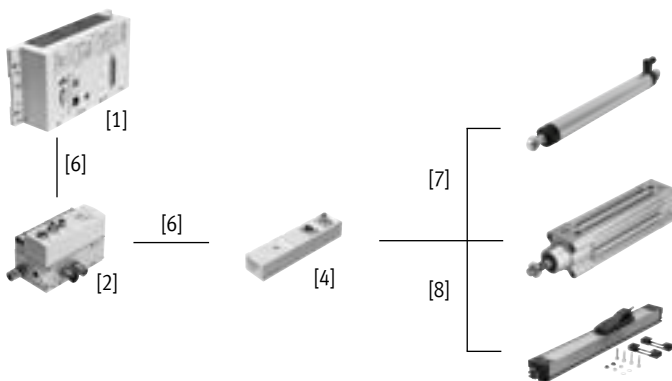

- [1] Controller module CPX-CMPX or CPX-CMAX
- [2] Proportional directional control valve VPWP
- [4] Sensor interface CASM-S-D2-R3
- [6] Connecting cable KVI-CP-3-...
- [7] Connecting cable NEBC-P1W4-K-0.3-N-M12G5
- [8] Connecting cable NEBC-A1W3-K-0.4-N-M12G5

- Attachable potentiometers with absolute measurement, with high degree of protection
- With connecting rod or moment compensator
- Measuring range:  
Connecting rod: 100 ... 750 mm  
Moment compensator: 225 ... 2000 mm
- Pre-assembled cables guarantee faultless and fast connection with the sensor interface CASM
- Range of applications: Soft Stop and pneumatic positioning with cylinder diameter 25 ... 80 mm
- Loads from 1 ... 300 kg

## Advantages:

- Easy installation and fast commissioning
- Cost-effective
- Can also be used in harsh ambient conditions
- Variety of drives: CPX-CMPX and CPX-CMAX also support cylinders with external displacement encoder

## Drive options

System components for Soft Stop systems with end-position controller CPX-CMAX							
[3]		Linear drive	Standards-based cylinder	Semi-rotary drive	Displacement encoder		→ Page/ Internet
		DDL/DGCI	DNCI/DDPC	DSMI	MLO-LWG/-TLF	MME-MTS	
[1]	Axis controller CPX-CMAX	■	■	■	■	■	8
[2]	Proportional directional control valve VPWP	■	■	■	■	■	vpwp
[4]	Sensor interface CASM-S-D2-R3	-	-	■	■	-	casm
[5]	Sensor interface CASM-S-D3-R7	-	■	-	-	-	casm
[6]	Connecting cable KVI-CP-3-...	■	■	■	■	■	10
[7]	Connecting cable NEBC-P1W4-...	-	-	■	■ / -	-	nebc
[8]	Connecting cable NEBC-A1W3-...	-	-	-	- / ■	-	nebc
-	Connecting cable NEBP-M16W6-...	-	-	-	-	■	vpwp

## Type codes and peripherals overview

### Type codes

001	Series	003	Axes
CPX-CMAX	Axis controller for electrical terminal	1	One
002	Function module		
C1	Controller		

### Peripherals overview

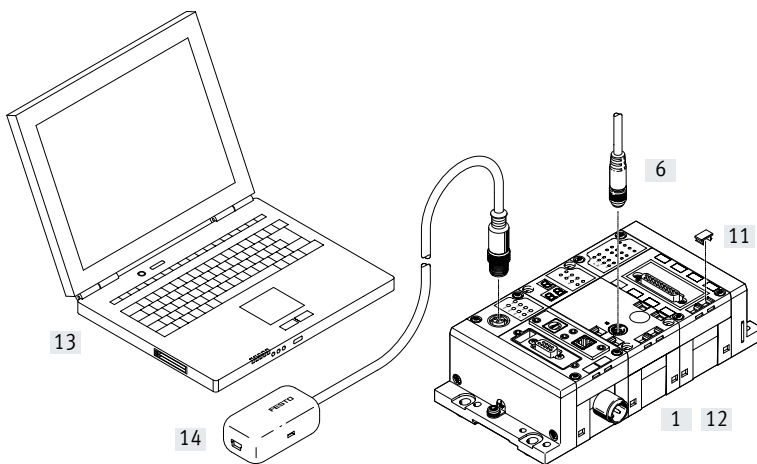

Accessories			→ Page/Internet
Type		Brief description	
[1]	Axis controller CPX-CMAX	Integrated in the CPX terminal. Screws for mounting on the polymer interlinking block are included in the scope of delivery	8
[6]	Connecting cable KVI-CP-3	For connecting axis controller CPX-CMAX and proportional directional control valve VPWP	10
[11]	Inscription label IBS	For labelling the modules	10
[12]	Interlinking block CPX-GE	Connects the individual modules. Two versions are available: polymer or metal interlinking block.	11
[13]	Laptop	The CMAX can be configured and commissioned using the FCT software (Festo Configuration Tool)	–
[14]	Adapter NEFC	For connecting the interface on the CPX node with the PC. A standard USB cable with mini USB plug is also required	11
–	Screws CPX-M-M3	For mounting on the metal interlinking block	10

## Data sheet

The axis controller CPX-CMAX is intended exclusively for use in valve terminals CPX.

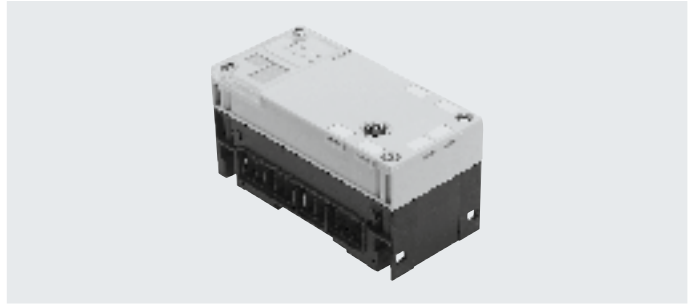

### General technical data

#### Operating voltage

Operating voltage range	[V DC]	18 ... 30
Nominal operating voltage	[V DC]	24
Current consumption at nominal operating voltage	[mA]	200
Fuse protection (short circuit)		Electronic
Power failure buffering	[ms]	10

#### Load voltage

Load voltage range	[V DC]	20 ... 30
Nominal load voltage	[V DC]	24
Permissible load current	[A]	2.5
Fuse protection (short circuit)		Electronic

Number of axis strings		1	
Axes per string		1	
Length of connecting cable to axis	[m]	≤ 30	
Max. number of modules		7	
Display		7-segment display	
Assigned addresses	Outputs	[bit]	8x8
	Inputs	[bit]	8x8
Operating modes			Record mode
			Direct mode
Controller types			Position control
			Force control
Diagnostics			Module-orientated
			Via local 7-segment display
Status indication			Module status
			Power load
			Display/Error Axis X
			MC Axis X

#### Control interface

Data			CAN bus with Festo protocol
			Digital
Electrical connection			5-pin
			M9
			Socket

Materials: housing			Reinforced PA
Note on materials			RoHS-compliant
Product weight		[g]	140
Dimensions	Length	[mm]	107
	Width	[mm]	50
	Height	[mm]	55



## Data sheet

Operating and environmental conditions		
Ambient temperature	[°C]	-5 ... +50
Relative humidity	[%]	5 ... 95, non-condensing
Degree of protection to IEC 60529		IP65

### Connection and display elements

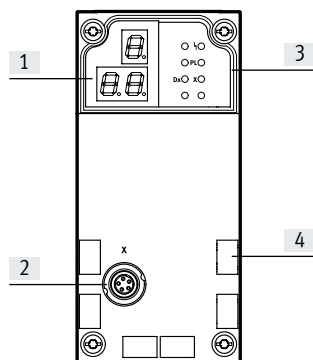





- [1] 3-digit display
- [2] Control interface
- [3] Status LEDs
- [4] Inscription labels

Pin allocation – Control interface			
	Pin	Signal	Designation
	1	+24 V	Nominal operating voltage
	2	+24 V	Load voltage
	3	0 V	Ground
	4	CAN_H	CAN high
	5	CAN_L	CAN low
	Housing	Shielding	Cable shielding

Permitted bus nodes/CEC		
Bus node/CEC	Protocol	Max. number of CMAX modules
CPX-CEC...	-	8
CPX-FB6	INTERBUS	1
CPX-FB11	DeviceNet <sup>1)</sup>	8
CPX-FB13	PROFIBUS <sup>2)</sup>	8
CPX-FB14	CANopen	4
CPX-M-FB21	INTERBUS	1
CPX-FB23-24	CC-LINK	4 (as functional module F23)
		8 (as functional module F24)
CPX-FB33	PROFINET RT, M12	8
CPX-M-FB34	PROFINET RT, RJ45	8
CPX-M-FB35	PROFINET RT, SCRJ	8
CPX-FB36	EtherNet/IP	8
CPX-FB37	EtherCAT	8
CPX-FB39	Sercos III	8
CPX-FB40	POWERLINK	8
CPX-FB43	PROFINET RT, M12	8
CPX-M-FB44	PROFINET RT, RJ45	8
CPX-M-FB45	PROFINET RT, SCRJ	8

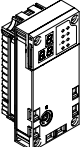
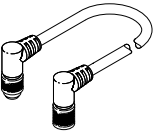

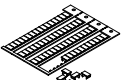
1) As of revision 20 (R20)  
 2) As of revision 23 (R23)

## Accessories

Ordering data	Brief description	Part no.	Type	
<b>Axis controller</b>				
	Order code in the CPX configurator: T21	548932	CPX-CMAX-C1-1	
<b>Connecting cable</b>				
	Connecting cable with angled plug and angled socket	0.25 m	540327	KVI-CP-3-WS-WD-0.25
		0.5 m	540328	KVI-CP-3-WS-WD-0.5
		2 m	540329	KVI-CP-3-WS-WD-2
		5 m	540330	KVI-CP-3-WS-WD-5
		8 m	540331	KVI-CP-3-WS-WD-8
	Connecting cable with straight plug and straight socket	2 m	540332	KVI-CP-3-GS-GD-2
		5 m	540333	KVI-CP-3-GS-GD-5
		8 m	540334	KVI-CP-3-GS-GD-8
	Connecting component for control cabinet through-feed	543252	KVI-CP-3-SSD	
<b>Screws</b>				
	For mounting on the metal interlinking block	550219	CPX-M-M3X22-4X	
<b>Inscription labels</b>				
	Inscription labels 6x10, in frames	64 pieces	18576	IBS-6X10
<b>User documentation</b>				
	Description of axis controller CPX-CMAX <sup>1)</sup>	German	559750	P.BE-CPX-CMAX-SYS-DE
		English	559751	P.BE-CPX-CMAX-SYS-EN
		Spanish	559752	P.BE-CPX-CMAX-SYS-ES
		French	559753	P.BE-CPX-CMAX-SYS-FR
		Italian	559754	P.BE-CPX-CMAX-SYS-IT

1) User documentation in paper form is not included in the scope of delivery

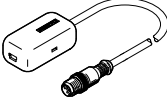
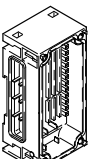
## Accessories

Ordering data	Brief description	Part no.	Type	
<b>Adapter</b>				
	Adapter from 5-pin M12 to mini USB bushing and controller software	547432	NEFC-M12G5-0.3-U1G5	
<b>Polymer interlinking block as extension block</b>				
	Without power supply	-	195742	CPX-GE-EV
	With additional supply for outputs	M18 - 4-pin	195744	CPX-GE-EV-Z
		7/8" - 5-pin	541248	CPX-GE-EV-Z-7/8-5POL
		7/8" - 4-pin	541250	CPX-GE-EV-Z-7/8-4POL
	With additional power supply for valves	M18 - 4-pin	533577	CPX-GE-EV-V
7/8" - 4-pin		541252	CPX-GE-EV-V-7/8-4POL	
<b>Tie rod</b>				
	For expansion using an interlinking block	1 module	525418	CPX-ZA-1-E